

CATI2014E

REV _ September 2014

Elleci Customer Service always by your side.

Do you need help?

Fill out the free form on our website, www.elleci.com, and one of our operators will contact you sooner as possible. Among the inquiries, you need to provide personal data, product category, purchasing details, problem description, two pictures (one of the entire product and one referring to details) and product's tax document.

ELLECI s.p.a. 04014 PONTINIA (LT)
Italy - Via Migliara, 53 - Z.I. Mazzocchio
Tel. +39.0773 840036 (r.a.)
Fax +39.0773 853517
www.elleci.com - E.mail: elleci@elleci.it

www.elleci.com



www.antonitabasco.it

ELLECI Catalogue 2014/15

ELLECI Catalogue 2014/15





100% Antibacterial protection - pure glass micro spherical sections - Hydrophobic: it does not absorb water
Lipophobic: it does not absorb greases - Extremely smooth and sturdy surface - Whitening and thermal shocks resistance

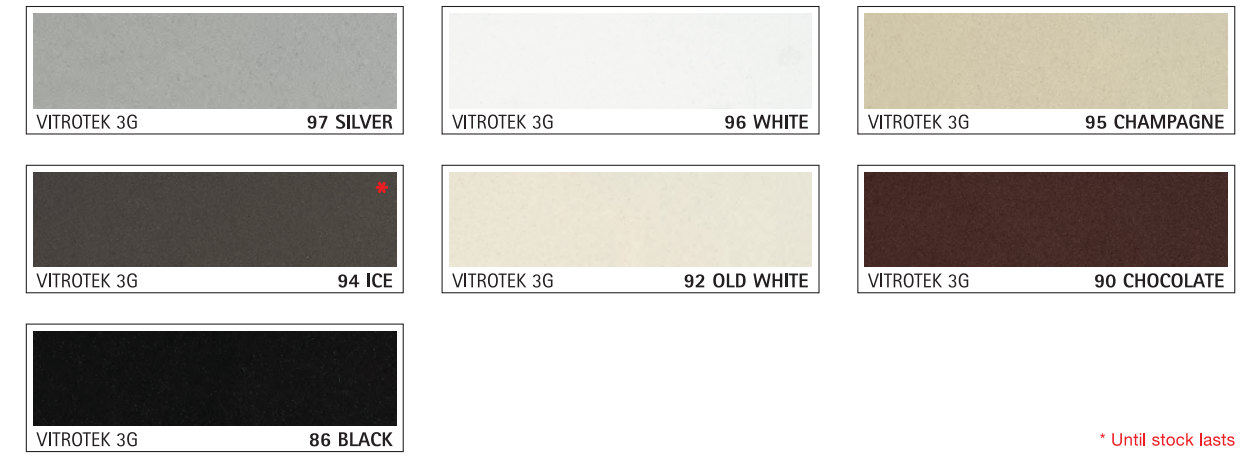

* Until stock lasts



Antibacterial protection - Natural Granite - Sturdiness and highest temperatures resistance
Thermal shocks resistance - Violent impacts and stains resistance



* Until stock lasts



Antibacterial protection - Natural Granite with metallic effect - Bright and brilliant finishing
Thermal shocks resistance - Violent impacts and stains resistance

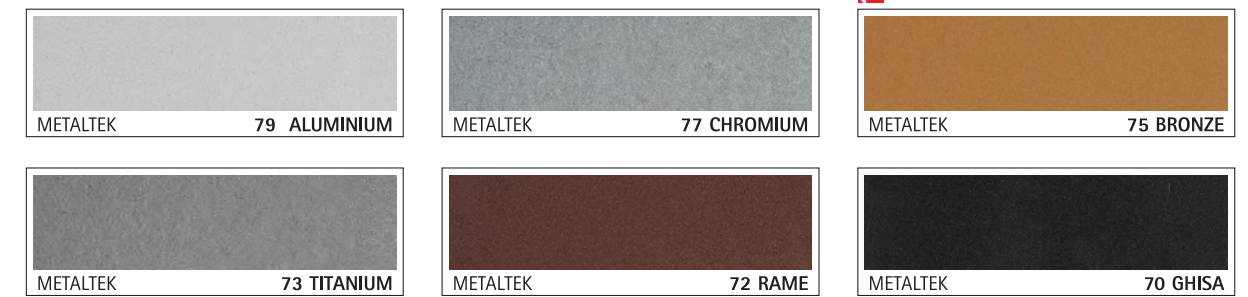

A composite mixture made up of modified acrylic resin and silanated micronized quartz.
Silane is a binding element between resin and quartz aimed to guarantee components high adhesion.
The mixture is coloured in the mass with special colorants.

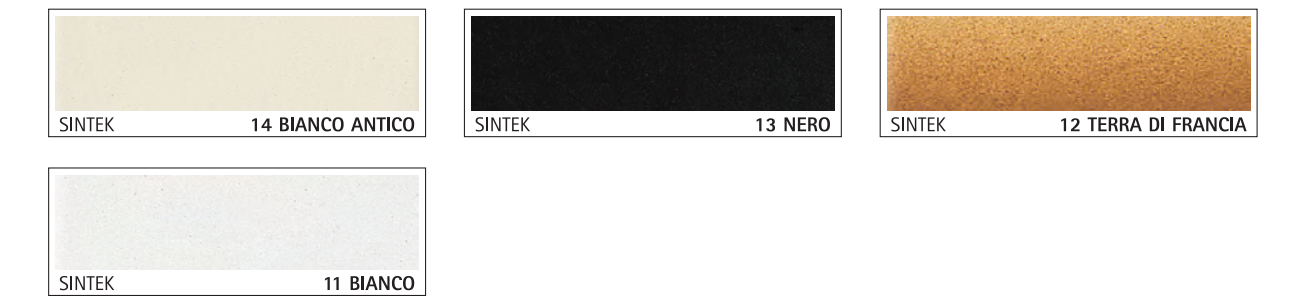

The Company The Know-How

For over **20 years** **Elleci** has been committed to achieve, what has always been considered the technological expression and the key point between past and future: **INNOVATION**. Thanks to the dedication to fulfil high quality and of authentic character projects, Elleci has turned to be nowadays “**Washing area expert with great attention to the colour matching in the kitchen environment**”.



Team Working

Elleci adopts the **TQM** (Total Quality Management), an organizational model based on the involvement of the whole company to reach the goal”.

The whole company structure is managed in order to overachieve in all those features of products and services important for the customer. One of the main targets of the company vision are its workers.

Management has always aimed to transfer them the vision, trying to let them share and accept those values that the vision requires and consequently each team member identifies himself and appreciates his role in the company.

In this way, over the years, everyone has been able to improve their competence, they have been encouraged to accept their responsibility and to participate to the company emotional intelligence creation.

Total Quality Management





*This important award has been conferred to the **DOGMA 100** and **SIREX** Electrosinks thanks to their unique and innovative features in terms of design and functionality.*



Our Team of engineers, chemists, researchers and designers analyses and test every single stage of production up to the finished product.



- Internal planning, construction and design.
- Use of high quality natural material.
- Use of italian semi-finished products and GPS moulding system Elleci patented.
- Elleci Quality Control
- Elleci Packaging

Certifications

100% Elleci certified quality



100% Made in Italy Certification

This certificate states that Elleci composite sinks are:

- manufactured in Italy;
- performed with Italian semi-finished products;
- realized with high quality and first choice natural materials;
- realized with Elleci exclusive design and planning;
- realized adopting typically Italian craft made working and traditional processes.



Elleci contributes to the sustainable production of street draining asphalts of new conception through the recycling of all the discarded sinks.

All the discarded materials deriving from Elleci industrial production (polystyrene, cartons, iron, sink discard, and so on) are totally collected in order to be used for the recycled materials production.

Material and energy recycling from civil and industrial wastes in the building industry is an optimal alternative for managing wastes and a safe solution for the collectivity and the environment. This system allows to save natural resources (non-renewable) and collect wastes in controlled conditions.

Elleci Green Green sink for Eco-asphalt production



Green products
respecting
human kind and
the planet that
hosts us!



FSC FSC Certifications

The FSC brand identifies those products coming from correctly and responsibly managed woods according to strict and rigorous environmental, social and economical standards. Woods supply us with clean water; fresh air and they help the fight against global heating.

If responsibly managed, woods, give great support to local communities and to the whole world. Unfortunately in some countries 80% of the woods are illegally cut.

SINCERT



SISTEMA
DI GESTIONE
CERTIFICATO
REG. N. 1543
UNI EN ISO 14001:2004

ISO 14001

Certification of the environmental system management. It certifies that Elleci works on the territory in an eco-friendly way, with great respect of the environment and of the laws.

This certificate contributes to improve the relation with our planet, and cut down the costs thanks to waste and refuse reduction.

Family value

Elleci is able to offer a wide range of sinks to match with cooking hobs, hoods, ovens and mixers. Clean lines with extreme attention to details, the style of a complete range of products that furnish your kitchen setting in harmony.

Many possibilities to have a unique and exceptional kitchen. Shown below some collections to orient oneself in the choice of the matchable products in many hints and in combination both modern and classic.

4
5



Elleci Italian design products are: contemporary, surprising and innovative. Our suites are designed to fulfil your real, everyday needs in the kitchen.



1 Ovens

The new oven collection is designed to cook any recipe. Clear lines, handy to use, easy to install and provided with many cooking programs to choose.

2 Cooking Tops

Integrated into the design of the kitchen, our new hobs with crystal or enamelled steel aesthetic, perfectly match with the design of ovens, hoods, sinks and mixers.

3 Hoods

Very silent, efficient, powerful: cooking with our hoods becomes a pleasure, not only for the guests. A range of different shapes and solutions allow to customize the cooking area.

4 Sinks

Our sinks, in various materials and forms, offer models with big personality and stylistic value, that can enhance the work plan of your kitchen both alone or in combination with cooking appliances.

5 Mixers

A collection designed for lived in kitchens. Clean lines, practicality, durability and aesthetic impact, are the common denominators of a complete set of harmonious and functional solutions.

For this reason our sinks, mixers, cooking top, ovens and hoods are functional, and full of talent and passion.

A thought to the design and one to those who live it.



Make your Elleci Suite



Bianco Titano Suite



Karisma 120 standard Sink
Granitek **68 bianco titano**
LGK12068BTP



Plano Oven
68 bianco titano
FGSP60168NS



Plano 60 t.c.L. Cooking Top
68 bianco titano
PGSP60168WS



Bridge Mixer
68 bianco titano
MGKBRI62



Plano Hood
96 white
KVP90096NTC

White Suite



Dogma 100 Electrosink
Vitrotek **3G 96 white**
EVD1009696E



Quadro Oven
96 white
FVQ60196NS



Quadro 70 t.c.c. Cooking Top
96 white
PVCQ70196CS



Invisio Elettronico
Mixer
EIKINVCR



Quadro Hood
96 white
KVQ80096VST

elleci suite



Aluminium Suite



Smart 400 Sink
Metaltek 79 aluminium
LMI40079SMT



Quadro Oven
79 aluminium
FMVQ60179NS



Quadro 70 tcc Cooking Top
79 aluminium
PMCQ70179CS



Blade Mixer
79 aluminium
MMKBLA79



Plano Hood
79 aluminium
KMP90079NTC

Black Suite



Value 130 inset Sink
Vitrotek 3G 86 black
LVV13086



Staves
Vitrotek 3G
AKD01386



Plano Oven
40/86 full black
FGSP60140NS



Plano 75 tcc Cooking Top
40/86 full black
PGSP75140CS



Just Mixer
40/86 full black
MVKJUS86



Quadro Hood
86 black
KVQ80086VST



White Suite



Sirex 400 Electrosink
Vitrotek 3G 96 white
EVI40096



Quadro Oven
96 white
FVVQ60196NS



Quadro 120 Cooking Top
96 white
PVCQ120196DS



Lighting
water flow

Arno Light Mixer
96 white
MVKARL96



Crystal Hood
96 white
KVC90096TST

Bianco Titano Green Suite



Karisma 105 Sink
Granitek 68 bianco titano
LGK10568



Plano Oven
68 bianco titano
FGSP60168NS



Plano 75 rcc Cooking Top
68 bianco titano
PGSP75168CS



Ares Mixer
96 white
MVKARE96



Food waste disposer
Green Power 750 TOP
TDH00750



Titanium Suite



Ego 400 Sink
Metaltek 73 titanium
LME40073



Quadro Oven
73 titanium
FMVQ60173NS



Quadro 60 TCL Cooking Top
73 titanium
PMCQ60173WS



Dove Plus Mixer
73 titanium
MMKDOP73

Aluminium Green Suite



Quadra 130 Sink
Metaltek 79 aluminium
LMQ13079



Quadro Oven
79 aluminium
FMVQ60179NS



Quadro 70 tcc Cooking Top
79 aluminium
PMCQ70179CS



Reno Plus Mixer
79 aluminium
MMKREP79



Food waste disposer
Green Power 1000 TOP
TDH01000



Full Black Suite



Easy 325 Sink
Granitek 40 full black
LGY32540



Plano Oven
40/86 full black
FGSP60140NS



Plano 60 t.c.L. Cooking Top
40/86 full black
PGSP60140WS



Just Mixer
40/86 full black
MVKJUS86



Quadro Hood
86 black
KVQ80086VST

White Suite



Tekno 500 Sink
Vitrotek 3G 96 white
LVT50096



Quadro Oven
96 white
FVVQ60196NS



Quadro 70 t.c.c. Cooking Top
96 white
PVCQ70196CS



Kube Mixer
96 white
MVKKUB96



Plano Hood
96 white
KVP90096NTC



Bianco Antico Suite



Master 400 Sink
Granitek 62 bianco antico
LGM40062



Bombè Oven
62 bianco antico
FGSB60262NY



Bombè 75 rcc Cooking Top
62 bianco antico
PGSB75262CY



Tago Mixer
62 bianco antico
MGKTAG62

Antracite Green Suite



Fox 360 Sink
Granitek 59 antracite
LGF36059



Bombè Oven
59 antracite
FGSB60259NY



Bombè 60 rcc Cooking Top
59 antracite
PGSB60259WY



Po Mixer
59 antracite
MGKPO59



Food waste disposer
Green Power 750 TOP
TDH00750



Bianco Titano Suite



Value 130 Sink
Vitrotek 3G 96 white
LW13096



Staves
Vitrotek 3G
AKD01396



Plano Oven
68 bianco titano
FGSP60168NS



Plano 75 rcc Cooking Top
68 bianco titano
PGSP75168CS



Fusion Plus Mixer
chrome
MIKFUPCR

Avena Suite



Ego 500 Sink
Granitek 51 avena
LGE50051



Bombè Oven
51 avena
FGSB60251NY



Bombè 60 rcl. Cooking Top
51 avena
PGSB60251WY



Titan Mixer
51 avena
MGKTIT51



Curve Hood
51 avena
KGU90051APM



Stainless steel Suite



Sky 360 Sink
Stainless steel
LIK360SAC



Plano Oven
Stainless steel
FIAP601INNS



Plano 75 tcc Cooking Top
Stainless steel
PIAP751INCS



Dove Mixer
chrome
MIKDOVCR



Crystal Hood
Stainless steel
KIC900INTST

Stainless steel Green Suite



River 400 Sink
Stainless steel
LIR400SACDX



Plano Oven
Stainless steel
FIAP601INNS



Plano 60 tcl Cooking Top
Stainless steel
PIAP601INWS



Stream Mixer
chrome
MIKSTRCR



Food waste disposer
Green Power 750 TOP
TDH00750

**De Luxe
Collection**



Washer 120 page 30



Max 1000 page 36



Max 900 page 40

**Dogma
Collection**



Dogma 100 page 50
CROMO DESIGN



Dogma 100 page 52



Dogma 90 page 54

**Sirex
Collection**



Sirex 500 page 64



Sirex 480 page 64



Sirex 475 page 65



Sirex 450 page 65



Sirex 400 page 66

**Smart
Collection**



Smart 500 page 80



Smart 480 page 80



Smart 475 page 81



Smart 450 page 81



Smart 400 page 82

**Value
Collection**

Inset
Undermount



Value 130 page 88

**Collezione
Karisma**

Inset
Undermount



Karisma 120 page 98/100



Karisma 105 page 98/100

**Collezione
Quadra**

Inset
Undermount



Quadra 350 page 157/163



Quadra 150 page 108/114



Quadra 130 page 108/114



Quadra 110 page 109/115



Quadra 105 page 109/115



Quadra 100 page 110/116



Quadra 50 page 110/116



Quadra 200 page 111/117



Quadra 210 page 111/117

**Tekno
Collection**



Tekno 500 page 124



Tekno 490 page 124



Tekno 480 page 125



Tekno 475 page 125



Tekno 450 page 126



Tekno 400 page 126



Tekno
Corner
page 127

Ego
Collection



Ego 500 page 134



Ego 480 page 134



Ego 475 page 135



Ego 450 page 135



Ego 400 page 136



Ego Esa page 136



Ego Corner page 137



Ego Round page 137

Easy
Collection



Easy 425 page 144



Easy 325 page 144



Easy 300 page 145



Easy 290 page 145



Easy 150 page 146



Easy 135 page 146



Easy Corner page 147



Easy Round 600 page 148

Fox
Collection



Fox 580 page 154



Fox 450 page 154



Fox 430 page 155



Fox 360 page 155



Fox 340 page 156



Fox 330 page 156



Fox 250 page 157



Fox 200 page 157



Fox Round page 158

Master
Collection



Master 550 page 164



Master 500 page 164



Master 475 page 165



Master 450 page 165



Master 400 page 166



Master 350 page 166



Master 300 page 167



Master Corner page 167

Living
Collection



Living 500 page 174



Living 475 page 174



Living 450 page 175



Living 400 page 175



Living 300 page 176



Living 125 page 176

**River
Collection**



River 500 page 184



River 475 page 184



River 450 page 185



River 400 page 185



River 350 page 186



River 300 page 186



River
Corner
page 187

**Sky
Collection**



Sky 550 page 192



Sky 500 page 192



Sky 480 page 193



Sky 475 page 193



Sky 450 page 194



Sky 400 page 194



Sky 360 page 195



Sky 350 page 195



Sky 300 page 196



Sky
Corner
page 196



Sky Round 510 page 197



Sky Round 435 page 197

**W-Square
Collection**

Inset
Undermount
Flushmount



W-Square 700 page 202



W-Square 500 page 202



W-Square 450 page 203



W-Square 400 page 203



W-Square 340 page 204

**Square
Collection**

Inset
Undermount



Square 720 2V page 208



Square 500 page 208



Square 340 page 209

Square R14
Collection

Inset
Undermount



Square 720 2v R14 page 214



Square 720 R14 page 214



Square 500 R14 page 215



Square 340 R14 page 215

Space R15
Collection

Undermount



Space 500 R15 page 220



Space 450 R15 page 220



Space 400 R15 page 220



Space 340 R15 page 220

Space R50
Collection

Undermount



Space 500 R50 page 224



Space 455 R50 page 224



Space 450 R50 page 224



Space 405 R50 page 224



Space 400 R50 page 225



Space 340 R50 page 225



Space 290 R50 page 225



Space 130 R50 page 225

Special
Collection

Inset
Undermount



Special ESA 920 page 229



Special ESA 770 page 229



Special ROUND 830 page 229

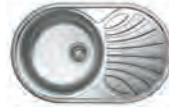

Special ROUND 770 page 229



Special 350 page 230



Special 300 page 230



Special 250 page 230



Special 250 sottotop page 230



Special 135 page 231



Special 125 page 231



Special 100 page 231

Mixers
Collection



Madeira page 237



Indo page 237



Invisio electronic page 238



Invisio mechanical page 238



Fusion Plus page 239



Fusion page 239



Chef page 240



Dionisio page 240



Fly page 241



Tevere page 241



Arno page 242



Arno Light page 242



Gange page 244



Tigri page 244



Just Plus page 245



Just page 245



Kube page 246



Cupido page 246



Blade page 249



Sunny page 250



Moony page 250



Ares page 251



Volta page 251



Dove Plus page 252

Mixers
Collection



Dove page 252



Stream Plus page 255



Stream page 255



Bridge page 256



Titan page 258



Reno Plus page 259



Reno page 259



Sava page 260



Danubio page 260



Urano page 261



Atena page 261



Po page 262



Teseo page 262



Senna page 263



Venere page 263



Minerva page 264



Vulcano page 264



Queen page 265



Rio page 266



Tago page 266



Elba page 267

**Food waste
disposers**
Collection



Model 1000 TOP
page 272



Model 750 TOP
page 272



Model 750
page 273



Model 500 TOP
page 273



Model 500
page 274

**Ovens
Collection**



Quadro page 280



Plano page 284



Bombè page 288



**Cooking
Tops
Collection**



Quadro 120 page 294



Quadro 70 tcc page 296



Quadro 60 tcl page 298



Plano 75 tcc page 300



**Cooking
Tops
Collection**



Plano 60 rcl page 302



Bombè 75 rcc page 304



Bombè 60 rcl page 306



Style 90 rcc page 308



Style 75 rcl page 309



Style 75 rcc page 310



Style 60 rcl page 311



Style 60 page 312



**Hoods
Collection**



Quadro page 318



Plano page 320



Crystal page 322



Curve page 324

Base

DE LUXE
Collection

DOGMA
Collection

SIREX
Collection

SMART
Collection

VALUE
Collection

KARISMA
Collection

300 mm

450 mm

500 mm

600 mm

800 mm

900 mm

1000 mm

1200 mm

corner



Sirex 400



Smart 400



Sirex 480



Smart 480



Sirex 475



Smart 475



Karisma 105
Karisma 105 UNDERMOUNT



Sirex 500



Smart 500



Value 130
Value 130 UNDERMOUNT



Karisma 120
Karisma 120 UNDERMOUNT



Dogma 100 CROMO DESIGN
Dogma 100
Dogma 90



Sirex 450



Smart 450



Washer 120 L.E.
Washer 120
Max 1000
Max 900

Collezione
QUADRA

Collezione
TEKNO

Collezione
EGO

Collezione
EASY

Collezione
FOX

Collezione
MASTER

Collezione
LIVING



Quadra 50 STANDARD
Quadra 50 SOTTOTOP



Quadra 100 STANDARD
Quadra 100 SOTTOTOP



Ego 400



Easy 135
Easy Round 600



Fox Round

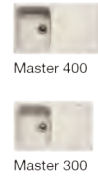

Master 400
Master 300



Living 400/300
Living 125



Tekno 400



Ego Round



Easy 300
Easy 290



Quadra 150 STANDARD
Quadra 150 SOTTOTOP
Quadra 110 STANDARD
Quadra 110 SOTTOTOP
Quadra 105 STANDARD
Quadra 105 SOTTOTOP

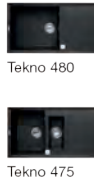

Tekno 480
Tekno 475



Ego 480
Ego 475



Easy 425
Easy 325/150



Fox 250
Fox 200

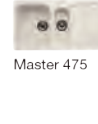

Master 475

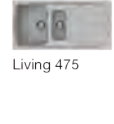

Living 475



Quadra 130 STANDARD
Quadra 130 SOTTOTOP



Tekno 500



Ego 500
Ego Esa



Easy Corner



Fox 330
Fox 340

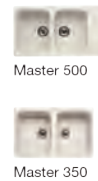

Master 500
Master 350



Living 500



Quadra 200 STANDARD
Quadra 200 SOTTOTOP



Tekno 450

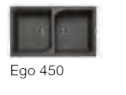

Ego 450



Fox 450/430
Fox 360



Master 450



Living 450



Tekno 490



Master 550



Quadra 210 STANDARD
Quadra 210 SOTTOTOP



Tekno Corner



Ego Corner



Easy Corner



Master Corner

Base

RIVER
Collection

SKY
Collection

W-SQUARE
Collection

300 mm



River 400



Sky 400



Sky 300



W-Square 340
INSET/UNDERMOUNT/FLUSHMOUNT

450 mm



River 300



Sky Round 510



Sky Round 435



W-Square 400 INSET/UNDERMOUNT/FLUSHMOUNT

500 mm



River 475



Sky 480



Sky 475



W-Square 500
INSET/UNDERMOUNT/FLUSHMOUNT



W-Square 400 INSET/UNDERMOUNT/FLUSHMOUNT

600 mm



River 500



Sky 500



W-Square 700
INSET/UNDERMOUNT/FLUSHMOUNT

800 mm



River 450



River 350



Sky 450



Sky 350

900 mm



Sky 360

1000 mm



Sky 550

corner



River Corner



Sky Corner

SQUARE
Collection

SPACE
Collection

SPECIAL
Collection



Space 130 R50 UNDERMOUNT



Square 340 INSET/UNDERMOUNT



Space 340 R50 UNDERMOUNT



Space 340 R15 UNDERMOUNT



Special Round 830



Special 300



Special 100



Square 340 R14 INSET/UNDERMOUNT



Space 290 R50 UNDERMOUNT



Special Round 770



Special 125



Space 405 R50 UNDERMOUNT



Space 400 R15 UNDERMOUNT



Special 135



Space 400 R50 UNDERMOUNT



Square 500 INSET/UNDERMOUNT



Space 500 R50 UNDERMOUNT



Space 455 R50 UNDERMOUNT



Special 250



Square 500 R14 INSET/UNDERMOUNT



Space 450 R50 UNDERMOUNT



Space 450/500 R15 UNDERMOUNT



Special Esa 770



Square 720 2V INSET/UNDERMOUNT



Square 720 R14 INSET/UNDERMOUNT



Space 450 R50 UNDERMOUNT



Space 450/500 R15 UNDERMOUNT



Special 350



Special 250 UNDERMOUNT



Square 720 2V R14 INSET/UNDERMOUNT



Special Esa 920



Square 720 R14 INSET/UNDERMOUNT





WASHER 120
2 bowls electrosink
FREE-STANDING WITH CABINET

MAX 1000
2 bowls electrosink
BUILT-IN

MAX 900
2 bowls electrosink
BUILT-IN

The exclusivity of our Electrosinks.

Curiosity drove us to bring the electronic into what traditionally is called sink. So a new product category was born, unique and functional in its kind. We call it: **Electrosink**.

WASHER 120

MAX 1000

MAX 900



28
29



The combination between water and electronic allows us to revolutionize the kitchen washing area giving a soul to the sink and getting it out of the inset bonds. The Electrosink becomes a new elegant furnishing component, integral part of the kitchen.

MISSION ELLECI

OUR MISSION IS TO REVOLUTIONIZE THE TRADITIONAL IMAGE OF THE KITCHEN SINK: ALL ALONG CONCEIVED LIKE A SIMPLE ACCESSORY, THE KITCHEN SINK CHANGES INTO A REAL AND INDEPENDENT FURNISHING ELEMENT, MARKED BY AN AUTHENTIC CHARACTER. THE EVOLUTION OF THE ELLECI DE LUXE PRODUCTS DOES NOT FOLLOW A TREND, BUT ATTENDS MAN AND HIS GESTURE IN HIS CREATIVITY.

Love for details, for finishes and quality of materials are the features which distinguish our products.



It means functionality, comfort, enhancing the qualities and characteristics of raw materials reaching maximum performance.

Innovation

It means technological research meeting the needs of product users.



WASTE OIL ASPIRATOR

Respect environment is a value through which we can improve our daily habits also in the kitchen. The comfortable oil aspirator, easily replaceable in the proper container, allows us to keep a suitable balance with nature. The collection of just 1 liter wasted oil, means the preservation of 10.000 square meters. Through the oil aspirator and a collecting tank placed underneath the sink, we can recover the exhausted oil so that it can easily disposed thanks to the simple operation of separate collection.



ULTRASOUND HYGIENIZATION

In these last years, hygienization used ultrasound system to get a safe cleaning until now reserved only for medical-surgical equipment. Ultrasound (high frequency vibrations) are able to produce pressure waves that continually generate microscopic balls which implode. The crash energy of these implosions improves the efficacy of this cleaning system since it can penetrate into little spaces or cavities of an object. Today, through detailed studies, it was possible to enlarge such use for all objects also in the kitchen field: in fact this process is able to ensure the complete elimination of bacterial microorganisms also on food, without the use of chemical detergents.

Ultrasound Hygienization: no detergent and running water needed; it is enough to dip the food or object to clean and activate the system for about 5 minutes. Ultrasound (high frequency vibrations) are able to ensure the complete elimination of bacterial organisms on any object or food (fruit, vegetables, bottles, glasses, rings, earrings).



nr. 5 drawers
180 litres
of usable space.



ACCESSORIES AREA

Practical soap dispenser, glasses drainer, food waste disposer or alternatively the glasswasher are only some of the available and customizable accessories in the washing block. Functionality and practicality in order to make easier the daily activities in the kitchen, reinventing the spaces.



FOOD WASTE DISPOSER

Essential appliance that frees us from organic waste. No bad smells anymore; waste reduction to be disposed. Practical conveyor funnel.



Alternatively to food waste disposer: GLASSWASHER.



Washer 120

2 bowls and cabinet electrosink
Dimension: **1200 x 730 mm**



Technical data

Electrical network connection: voltage 230 volts.

Maximum Absorbed Power

Washer 120 services: 130 W.
Ultrasound washing basin: 120 W.
Food waste disposer: 650 W.
Power supply services control device with security voltage at 24 volts.
Hydraulic connection: connection to the normal water consumption.

Connections:

Electrical: connecting wall socket.
Entering hydraulic (Hot/Cold water): normal flexible.
Exiting hydraulic (Drain): normal siphoning.
No adjustments and setting needed: self-adjustment machine.

Washer 120 Technical drawing

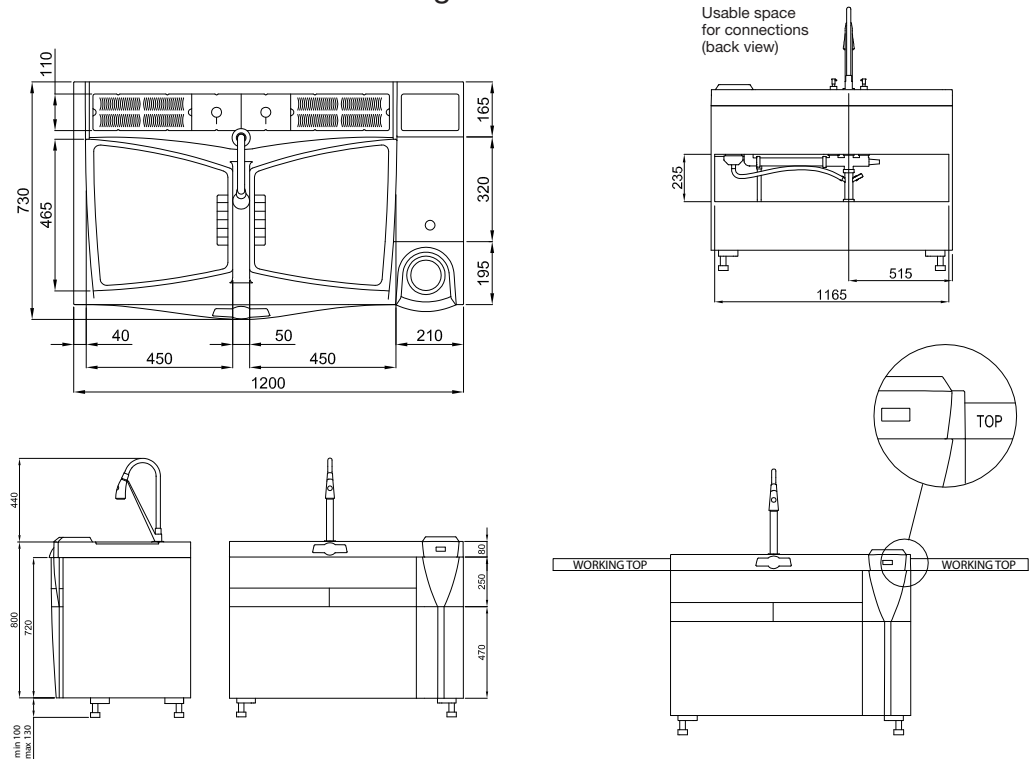

Available colours: WASHER 120 (see internal cover)

Washing block: **Vitrotek 3G:** 96 white - **Metaltek:** 79 aluminium - 73 titanium - **Granitek:** 62 bianco antico - 51 avena

Panelling: **Carbon fibre effect - Aluminium fibre effect - Neutral - Customized**

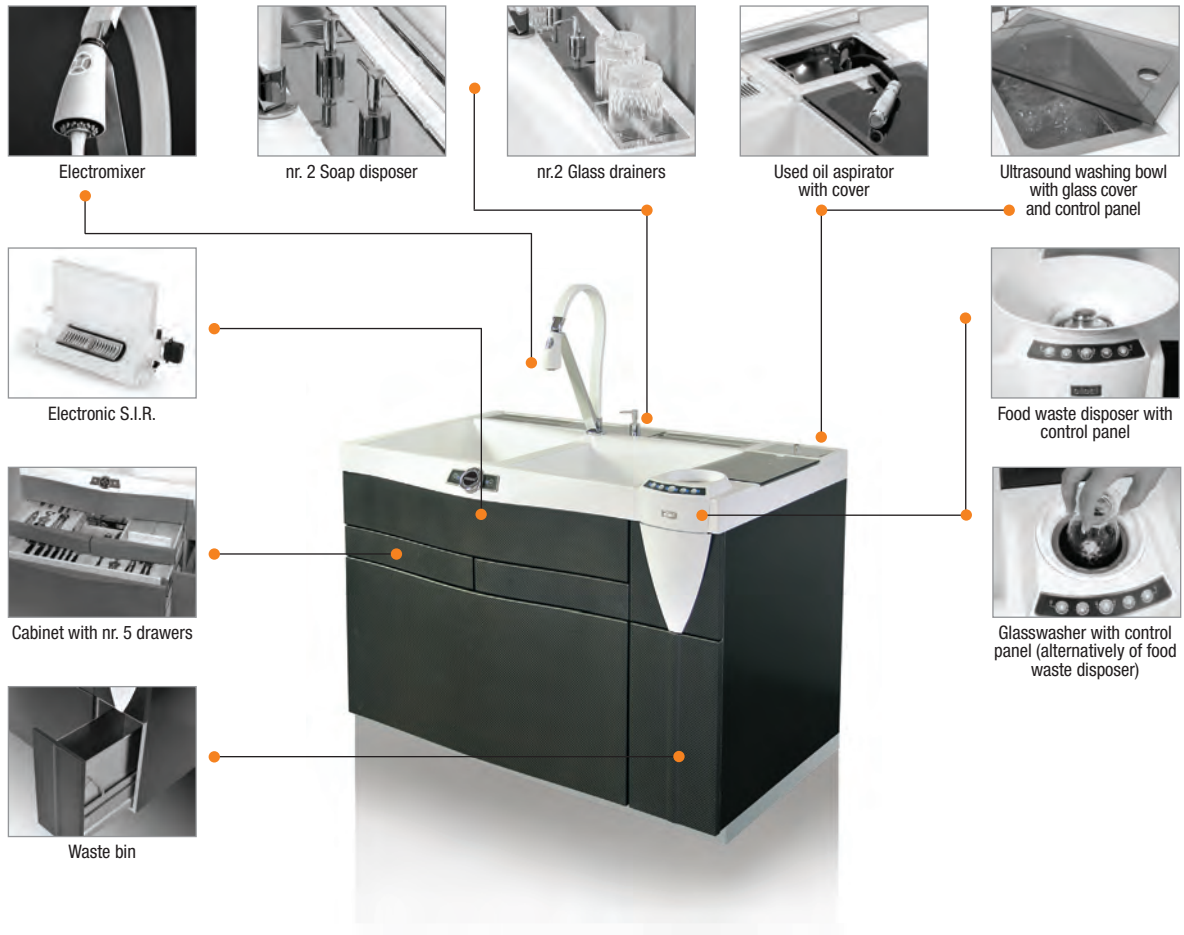

WASHER 120 Washing block colour choice

VITROTEK 3G



96 white

Code: EVW120 96

METALTEK



79 aluminium

Code: EMW120 79

METALTEK

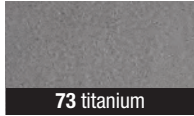

73 titanium

Code: EMW120 73

GRANITEK

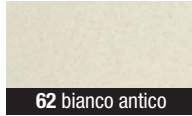

62 bianco antico

Code: EGW120 62

GRANITEK



51 avena

Code: EGW120 51

Panelling colour choice

FINISH

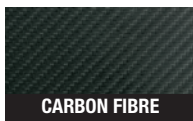

CARBON FIBRE

Code: CA



FINISH

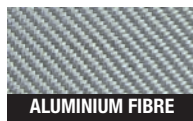

ALUMINIUM FIBRE

Code: AL



FINISH



NEUTRAL*

Code: NN



* surface to be painted by the installer

Electromixer choice

ELECTRA



Cromato

Code: ELE CR

ELECTRA



Vitrotek 3G 96 white

Code: ELE 96

VEGA



Cromato

Code: VEG CR

VEGA



Granitek 79 aluminium

Code: VEG 79

VEGA



Granitek 51 avena

Code: VEG 51

Versions



CONFIGURATIONS	CM 000	CM 004	CE 000	CE 004	CM 001	CM 005	CE 001	CE 005
Electronic S.I.R.	●	●	●	●	●	●	●	●
S.I.R. Control panel	●	●	●	●	●	●	●	●
Ecofunctional area control panel	●	●	●	●	●	●	●	●
Ultrasound washing block with glass cover and control panel	●	●	●	●	●	●	●	●
Food waste disposer with control panel	●		●		●		●	
Glasswasher with control panel		●		●		●		●
Little bowl sponge holder with cover	●	●	●	●				
Used oil aspirator with cover					●	●	●	●
Nr. 2 Soap disposers	●	●	●	●	●	●	●	●
Nr. 2 glass drainers	●	●	●	●	●	●	●	●
Stainless steel basket	●	●	●	●	●	●	●	●
Electromixer	●	●	●	●	●	●	●	●
Cabinet with nr. 5 drawers	●	●	●	●	●	●	●	●
Waste bin	●	●	●	●	●	●	●	●
Mechanical guides	●	●			●	●		
Electronic guides			●	●			●	●

Final configuration example: washing block colour + panelling colour + version + electromixer.

Code: **EWV 120 96 CA CE001 ELE96**

<p>VITROTEK 3G</p>  <p>96 white</p> <p>EWV120 96</p>	+	<p>FINISH</p>  <p>FIBRA DI CARBONIO</p> <p>EWV120 96 + CA</p>	+	<p>VERSION</p>  <p>EWV120 96 CA + CE001</p>	+	<p>ELECTRA</p>  <p>Vitrotek 3G 96 white</p> <p>EWV120 96 CA CE001 + ELE96</p>
--	---	---	---	--	---	---

OPTION 1 Accessories choice - Washer 120 drawers

KIT option 1

LITTLE RIGHT SIDE DRAWER

Dividing for cutlery



Code: **AKS12000**

LITTLE LEFT SIDE DRAWER

Cutlery tray, including a set for 6



Code: **AKS11001**

FOLDAWAY DRAWER

Nr. 6 knives different dimensions, nr.1 knife sharpener, ice cream slice, slice, strainer, grater, bottle opener, potato peeler, corkscrew, nutcracker, tin opener.



Code: **AKS13000**

BIG DRAWER

Empty pans, pots and dishes tray.



Code: **AKS14001**

* It is possible make a free selection between options 1 and 2.

OPTION 2 Accessories choice - Washer 120 drawers

KIT option 2

LITTLE RIGHT SIDE DRAWER

Cutlery tray, including a set for six.



Code: **AKS12001**

LITTLE LEFT SIDE DRAWER

Utensil tray (nr. 7 utensils potato peeler, slice, grater, bottle opener, nutcracker, corkscrew, tin opener).



Code: **AKS11000**

FOLDAWAY DRAWER

Empty cutlery tray with a nr. 6 knives set different dimensions.



Code: **AKS13001**

BIG DRAWER

Empty pans, pots and dishes tray.

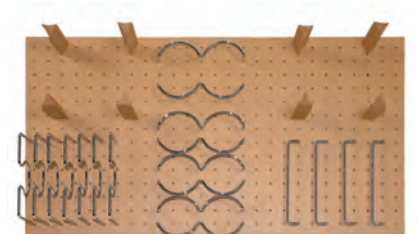

Code: **AKS14000**

* It is possible make a free selection between options 1 and 2.

Spare part section

- 1 - LITTLE RIGHT SIDE DRAWER
- 2 - LITTLE LEFT SIDE DRAWER
- 3 - FOLDAWAY DRAWER
- 4 - BIG DRAWER



CPA11000
Exhausted oil tank, 5 liters.

Customized panelling

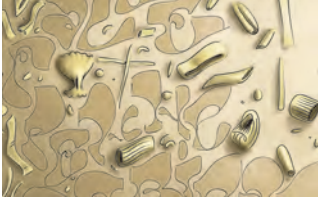

subject: **Pasta**



subject: **Carrots**



subject: **Crab**



subject: **Cutlery**



subject: **Wine**

Washer 120 Limited Edition: customized and hand made.

Marco Longo, the winner of “**YOUNG DESIGNERS AWARDS LAZIO**” competition proposed a collection composed by n.10 Washer 120 customizations, painting by hand the frontal panels in polyurethane, with different techniques (spray or aerograph). Ten proposals are divided in three categories: 3 “**Warm**”, 3 “**Cold**”, 3 “**Fresh**” and one “**Graffiti**”; realized with free hand spray.

YOUR OWN WASHER: We have to specify that this collection represents only a very little series of the possible customizations on the electrosink frontal panels. In fact, you can get the panels according to your own preferred theme, work of art, style or colour. Our young Street Artist **Marco Longo** will be at your disposal for “sketching” **YOUR OWN WASHER**.

Electrosinks like pictures, windows on a fairy-tale world: softness inscribed in a specified perimeter, which brings us to a contemporary pragmatism, to a new need for discipline. All is researched, but simplified. Few formalities, revaluation of manual working and a visionary interpretation of **Elleci** spirit. Escaping from inflation of digital techniques, the drawings on the 5 frontal panels **Washer 120 Limited Edition** are unpublished and handmade. Shapes linearity, geometric sense and primary solution return, confer lightness to the whole. Harmony is the balance among roundness, fantastic digressions, virtuosities and a strong essentiality sense. Thoroughness, optical and perceptual illusions, for a dense and rich whole, with touches of eccentricity.



Max 1000

2 bowls and cabinet electrosink

Dimension: **1200 x 730 mm**

Built-in hole: **1160 x 510 mm**



Technical data

Electrical network connection: voltage 230 volts.

Maximum Absorbed Power

Max 1000 services: 60 W.

Ultrasound washing basin: 120 W.

Food waste disposer: 650 W.

Power supply services control device with security voltage at 24 volts.

Hydraulic connection: connection to the normal water consumption.

Connections:

Electrical: connecting wall socket.
Entering hydraulic (Hot/Cold water): normal flexible.

Exiting hydraulic (Drain): normal siphoning.

No adjustments and setting needed: self-adjustment machine.

Max 1000 Technical drawing

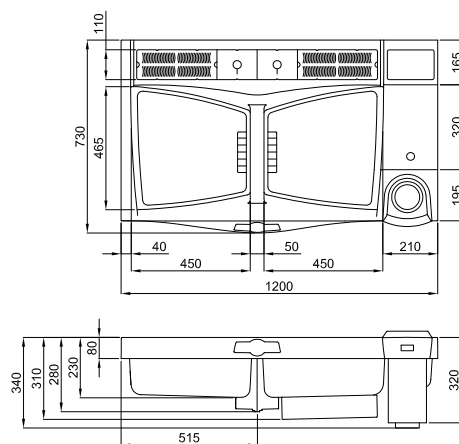

In order to get a better aesthetic is suggested to opt for full-length handles or push and pull system.

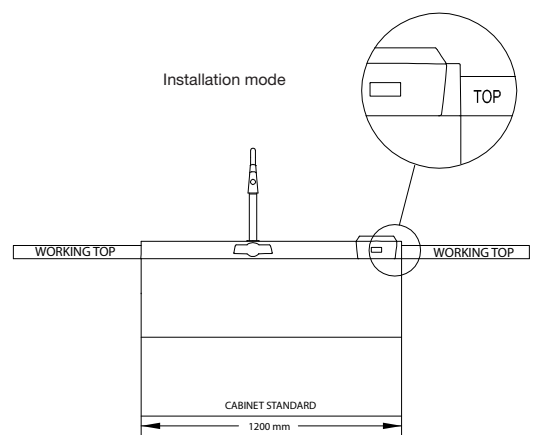

Available colours: **MAX 1000** (see internal cover)

Washing block: **Vitrotek 3G: 96** white - **Metaltek: 79** aluminium - **73** titanium - **Granitek: 62** bianco antico - **51** avena



Electronic S.I.R.



S.I.R. control panel



Ecofunctional area control panel



Food waste disposer



Glasswasher



nr. 2 Soap dispenser

Max 1000 electrosink is the interpretation of a dynamic life style, trust in technology and ecology. Many concepts in Max 1000 that match in the pleasure of washing area daily living.



nr. 2 Glasses drainer



Used oil aspirator with cover



Ultrasound washing bowl with glass cover



Mod. **MAX 1000**
Washing block: **Metaltek 79** Aluminium
Electromixer: **Vega Metaltek 79** Aluminium finish

MAX 1000 Washing block colour choice

VITROTEK 3G



96 white

Code: EVX100 96C

METALTEK



79 aluminium

Code: EMX100 79C

METALTEK



73 titanium

Code: EMX100 73C

GRANITEK



62 bianco antico

Code: EGX100 62C

GRANITEK



51 avena

Code: EGX100 51C

Versioni



CONFIGURATIONS	000	004	002	008	001	006	010	005	003	009	007	011
Electronic S.I.R.	●	●	●	●	●	●	●	●	●	●	●	●
S.I.R. Control panel	●	●	●	●	●	●	●	●	●	●	●	●
Ecofunctional area control panel			●	●		●	●		●	●	●	●
Ultrasound washing block with glass cover and control panel					●			●	●	●	●	●
Auxiliary bowl	●	●	●	●		●	●					
Food waste disposer with control panel			●			●			●		●	
Glasswasher with control panel				●			●			●		●
N. 1 small wooden chopping board	●	●			●			●				
N. 1 big wooden chopping board	●	●	●	●		●	●					
Little bowl sponge holder with cover	●		●	●	●				●	●		
Nr. 2 soap disposers	●	●	●	●	●	●	●	●	●	●	●	●
Nr. 2 glass drainers	●	●	●	●	●	●	●	●	●	●	●	●
Used oil aspirator with cover		●				●	●	●			●	●

Final configuration example: washing block colour + version.

METALTEK

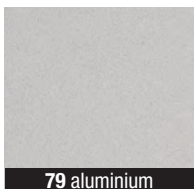

79 aluminium

EMX100 79C



VERSION 007



EMX100 79C + 007

Code: EMX 100 79C 007

Max 1000 Electromixer



finish Vitrotek 96 white chrome finish



finish Granitek 51 Avena chrome finish

finish Metaltek 79 aluminium



chrome finish finish Granitek 51 Avena

ELECTRA

EIKELECRDLX
chrome finish

EVKELE96DLX
finish 96 white

VEGA

EIKVEGCRDLX
chrome finish

EMKVEG79DLX
finish 79 aluminium

EGKVEG51DLX
finish 51 Avena

ARNO

MIKARNCRDLX
chrome finish

MGKARN51DLX
finish 51 Avena



The Electromixer has got a useful SCALD PROTECTION:
Buttons area colours indicate temperature level while opening: blu=cold / red= hot / purple=mixed. Central button function when faucet is turned off with hot water, you get mixed water flow with the same flow rate previously selected.



Flexible Electromixer with control on the shower
Double control (one placed on the shower head and the other one on the frontal control panel). A precise water temperature and flow regulation.

Max 1000 Accessories



ACI11301
Stainless steel basket



ADI01300
Stainless steel dish drainer



Max 900

2 bowls electrosink

Dimension: **1200 x 590 mm**

Built-in hole: **1160 x 510 mm**



Technical data

Electrical network connection: voltage 230 volts.

Maximum Absorbed Power

Max 900 services: 60 W.
 Ultrasound washing basin: 120 W.
 Food waste disposer: 650 W.
 Power supply services control device
 with security voltage at 24 volts.
 Hydraulic connection: connection to
 the normal water consumption.

Connections:

Electrical: connecting wall socket.
 Entering hydraulic (Hot/Cold water):
 normal flexible.
 Exiting hydraulic (Drain):
 normal siphoning.
 No adjustments and setting needed:
 self-adjustment machine.

Max 900 Technical drawing

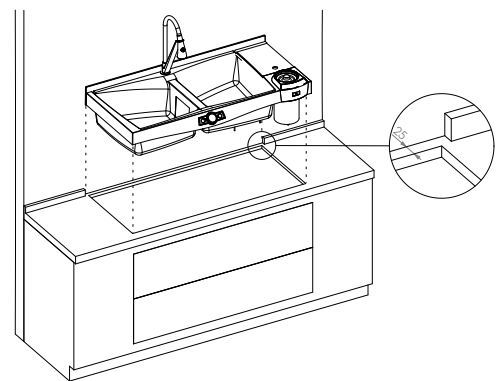
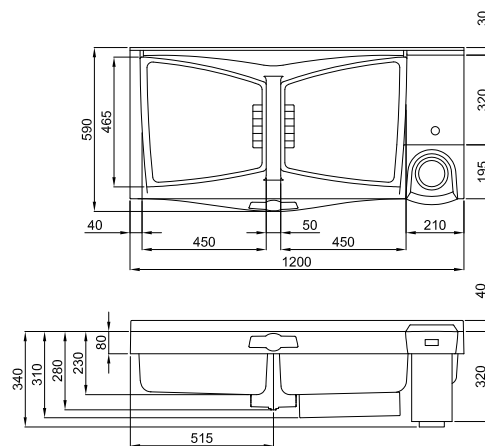

Available colours: MAX 900 (see internal cover)

Washing block: **Vitrotek 3G: 96** white - **Metaltek: 79** aluminium - **73** titanium - **Granitek: 62** bianco antico - **51** avena



Electronic S.I.R.



Ecofunctional area control panel



S.I.R. Control panel



Food waste disposer



Glasswasher



Ultrasound washing bowl with glass cover

The convenience of having everything within reach, accessibility, functionality and completeness in a single product. Max 900 represents a valid aesthetic and functional solution for those who want to enrich and reorganize the spaces in the washing area of their kitchen, both classic and moder.



Mod. **MAX 900**
Washing block: **Metaltek 73 Titanium**
Electromixer: **Electra Chrome** finish

MAX 900 Washing block colour choice

VITROTEK 3G



96 white

Code: EVX090 96C

METALTEK



79 aluminium

Code: EMX090 79C

METALTEK

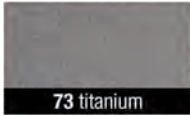

73 titanium

Code: EMX090 73C

GRANITEK



62 bianco antico

Code: EGX090 62C

GRANITEK



51 avena

Code: EGX090 51C

Versions



CONFIGURAZIONI	000	002	008	001	003	009
Electronic S.I.R.	●	●	●	●	●	●
S.I.R. Control panel	●	●	●	●	●	●
Ecofunctional area control panel		●	●		●	●
Ultrasound washing block with glass cover and control panel				●	●	●
Auxiliary bowl	●	●	●			
Food waste disposer with control panel		●			●	
Glasswashers with control panel			●			●
Nr. 1 small wooden chopping board	●			●		
Nr. 1 big wooden chopping board	●	●	●			

Final configuration example: washing block colour + version.

Code: EVX 090 96C 003

VITROTEK 3G



96 white

EVX090 96C



VERSION 003



EVX090 96C + 003

Max 900 Electromixer



finish Vitrotek **96** white chrome finish



finish Granitek **51** avena chrome finish

finish Metaltek **79** aluminium



chrome finish finish Granitek **51** avena

ELECTRA

EIKELE**CRDLX**
chrome finish

EVKELE**96DLX**
finish **96** white

VEGA

EIKVEG**CRDLX**
chrome finish

EMKVEG**79DLX**
finish **79** aluminium

EGKVEG**51DLX**
finish **51** avena

ARNO

MIKARN**CRDLX**
chrome finish

MGKARN**51DLX**
finish **51** avena



The Electromixer has got a useful SCALD PROTECTION:
Buttons area colours indicate temperature level while opening:
blu=cold / red= hot / purple=mixed. Central button function
when faucet is turned off with hot water, you get mixed water
flow with the same flow rate previously selected.

Flexible Electromixer with control on the shower
Double control (one placed on the shower head and the other
one on the frontal control panel). A precise water temperature
and flow regulation.



Max 900 Accessories



ACI11301
Stainless steel basket



ADI01300
Stainless steel dish drainer





reddot design award
honourable mention 2012

DOGMA

COLLECTION

Dogma 100 CROMO DESIGN
two bowl chromotherapeutic over-top electrosink

Dogma 100
two bowl electrosink over-top

Dogma 90
two bowl electrosink built-in

S.I.R. Compact Draining System



Innovative and patented Compact Draining System that allows the maximum optimization of the space underneath the electrosink, thanks to the limited 5 cm encumbrance. Better spaces exploitation and optimization under the electro sink. More bowl space available thanks to the particular lateral position of the SIR grid, which completely replaces the traditional and less functional waste.



60 litres/min.

No hole for the overflow: more beauty, safety and functionality.

Greater water down flow thanks to the lateral position of the grid.

Minimal composition, one element easy to clean. Thanks to a practical frontal panel it is possible to collect residual accidentally deposited within the SIR grid and make an extremely easy and precise periodical cleaning of the waste.

95% capacity of the space underneath the sink thanks to the optimization of the bowl bottom.

46
47

Despite having a generous 90 cm length, Dogma can be installed into a 90 cm base, using a 86 cm standard builtin sink inset hole.



Compact Draining System
Space under the sink: around 5 cm



Traditional Draining System
Space under the sink: around 30 cm

VS



Elleci electrosinks have a **TOTAL ANTIBACTERIAL PROTECTION**, which has an adequate antibacterial coverage of the mass. In this way the bacterial organisms are repelled. Reliability and practicality become a certainty every day in the kitchen.



Planned by Italian creativity.

DOGMA
CROMO DESIGN



Design by:
Davide Stolfi & Defne Dilber
Dilber & Stolfi Architectural Studio
is an industrial designing laboratory
set up in Rome in 2006
by Davide Stolfi and Defne Dilber
after a long cooperation
into Massimiliano Fuksas
international studio.

Dogma Cromo Design is an innovative chromotherapy electrosink. It is able to create a customized coloured atmosphere choosing both intensity gradation and cyclicity.



Red: this colour symbolizes strength, healthy and vitality; it represents fire, joy and fest.



Blue: it is a calming and refreshing colour, it lets you forget all daily problems.



Yellow: it is associated to the left brain side and generally to the intellectual one, with stimulating and support effects in studying. It is considered as a protective and concrete colour.



Orange: it has a liberating action on physical and mental functions; it induces to serenity, enthusiasm, cheerfulness, love for life, optimism, feelings positivity.



Fuchsia: it is the colour of thought and mind. It encourages inspiration, it controls irritability, it eases meditations and it induces to spirituality.

In the last few years, chromotherapy had a remarkable development thanks to several scientific studies that show the influence of colours on nervous, immune and metabolic systems.

Colour therapy has natural effects on body and mind, it is able to stimulate the body and to ease some symptoms. In colour therapy each colour is associated to particular psychic and spiritual features.

Egyptians, Romans and Greeks practiced the light therapy (direct exposure to sunlight) for the cure of several and different illnesses.
In India the Ayurvedic medicine always kept in mind how colours affect the chakra, energy centres associated to main glands of our body.
Chinese people as well trusted in different shades action for their wellbeing.



Chromotherapy has ancient origins, since the traditional medical sciences always gave a great importance to the colours influence on man healthy and mood.

Among several programs you can select “**PURE WHITE LIGHT**”.
White: it is the color of hope and trust in the others.
It encourages purity and wish of change.





Dogma 100 CROMO DESIGN

two bowl over-top electrosink
 Dimension: **945 x 505 mm**
 Built-in hole: **840 x 480 mm**



Accessories see page 57:

05 35 36 37 37.1 38 38.1



Packaging:
 carton and polystyrene, m³ 0,22 approx.

Kit of the sink:
 compact draining system (S.I.R.),
 premounted hooks and wireless
 remote control.



VITROTEK 3G	SIR	CODE
Sink 96 white / Collar 96 white	electronic	EVD100 9696 ECRD

Technical data

Electrical network connection:
 voltage **230 volt**.

Maximum Absorbed Power

Electronic S.I.R. management: 9 W
 S.C.T. management (Chromotherapy System):
 20W – 12W

Hydraulic connection:
 normal water consumption.

Connections:

Electrical: nr. 2 connecting wall sockets
 (one for SIR and one for S.C.T.).

Entering hydraulic (Hot/Cold water):
 normal flexible.

Exiting hydraulic (Drainer):
 normal siphoning.

No adjustment and setting needed:
 selfadjustment machine.

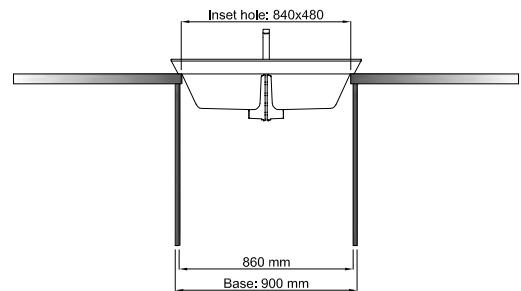

* 900 Base, not when it starts the composition.

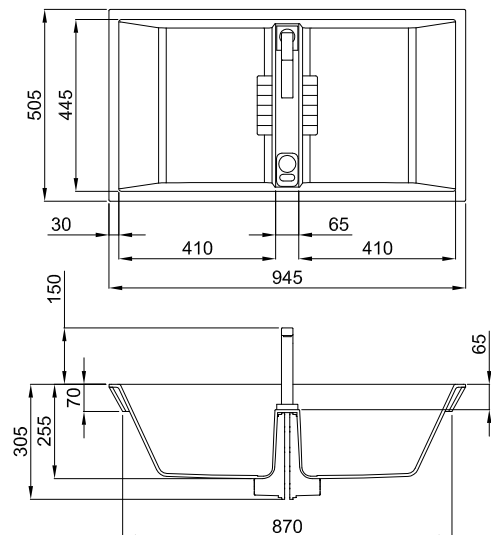

Wireless remote control for S.C.T. system

CHROMOTHERAPIC SYSTEM

Dogma 100 Cromo Design is equipped with led **Chromotherapy System (S.C.T.)** and controlled by a latest generation wireless remote control. According to your mood you can set your favourite colour by simply touching the ring of the wireless remote control. It is further possible to program several preset multicolour sequences and optimize the light intensity by means of special buttons.

Wireless remote control with Chromotherapy System (S.C.T.)

- ❶ ON Key. By repeatedly pushing the ON you can select your favourite S.C.T. program. Among several colours you can select "pure white light" program.
- ❷ OFF Key.
- ❸ Keys for setting the S.C.T. **program speed**.
- ❹ Keys for setting the S.C.T. **program light intensity**.





Dogma 100

two bowl over-top electrosink
 Dimension: **945 x 505 mm**
 Built-in hole: **840 x 480 mm**



Accessories see page 57:

05 35 36 37 38 37.1 38.1

Packaging:
 carton and polystyrene, m³ 0,22 approx.

Kit of the sink:
 S.I.R., siphon and premounted hooks.



VITROTEK 3G	SIR	CODE
Sink 96 white / Collar 96 white	electronic	EVD1009696E
Sink 86 black / Collar 86 black	electronic	EVD1008686E
Sink 86 black / Collar 96 white	electronic	EVD1008696E
Sink 96 white / Collar 86 black	electronic	EVD1009686E



METALTEK	SIR	CODE
Sink 79 aluminium / Collar 79 aluminium	electronic	EMD1007979E



GRANITEK	SIR	CODE
Sink 43 tortora / Collar 43 tortora	electronic	EGD1004343E

52
53



VITROTEK 3G	SIR	CODE
Sink 96 white / Collar 96 white	mechanical	EVD1009696M
Sink 86 black / Collar 86 black	mechanical	EVD1008686M
Sink 86 black / Collar 96 white	mechanical	EVD1008696M
Sink 96 white / Collar 86 black	mechanical	EVD1009686M



METALTEK	SIR	CODE
Sink 79 aluminium / Collar 79 aluminium	mechanical	EMD1007979M



GRANITEK	SIR	CODE
Sink 43 tortora / Collar 43 tortora	mechanical	EGD1004343M

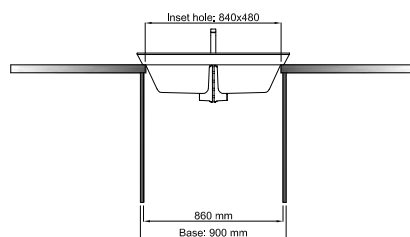

* 900 Base, not when it starts the composition.

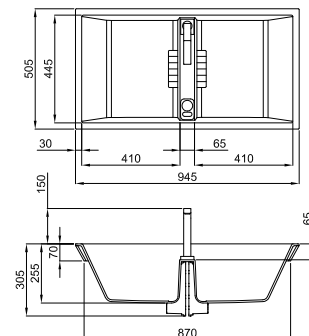

Available colours: **DOGMA 100** (see inside cover pages)

Vitrotek 3G: 96 white / 86 black

Metaltek: 79 aluminium

Granitek: 43 tortora



Technical data

Electrical network connection:
voltage 230 volt.

Maximum Absorbed Power

Electronic S.I.R. management: 15 W
Power supply services control device
with security voltage at 9 volt.

Hydraulic connection:
normal water consumption.

Connections:

Electrical: connecting wall socket.

Entering hydraulic (Hot/Cold):
normal flexible.

Exiting hydraulic (Drainer):
normal siphoning.

No adjustment and setting needed:
selfadjustment machine.



900

Base

Dogma 90

two bowl built-in electrosink

Dimension: **945 x 505 mm**

Built-in hole: **925 x 495 mm**

Electrosink for under window installation



Inset

Accessories see page 57:

05 35 37 38 37.1 38.1

Packaging:

carton and polystyrene, m³ 0,22 approx.

Kit of the sink:

S.I.R., siphon and premounted hooks.

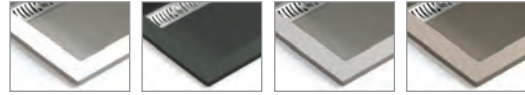

White 96

Black 86

Aluminium 79

Tortora 43



VITROTEK 3G

SIR

CODE

Sink **96 white**

electronic

EVD09096E

Sink **86 black**

electronic

EVD09086E



METALTEK

SIR

CODE

Sink **79 aluminium**

electronic

EMD09079E



GRANITEK

SIR

CODE

Sink **43 tortora**

electronic

EGD09043E



VITROTEK 3G

SIR

CODE

Sink **96 white**

mechanical

EVD09096M

Sink **86 black**

mechanical

EVD09086M



METALTEK

SIR

CODE

Sink **79 aluminium**

mechanical

EMD09079M



GRANITEK

SIR

CODE

Sink **43 tortora**

mechanical

EGD09043M

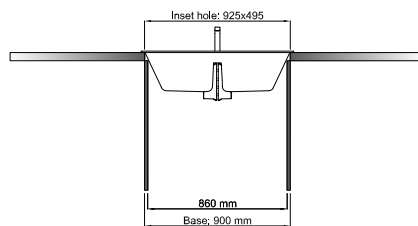

* 900 Base, not when it starts the composition.

The particular bowls geometry allows to built-in Dogma 90 in a 900 mm base.

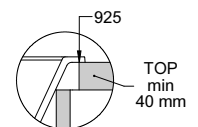
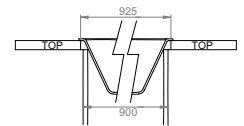
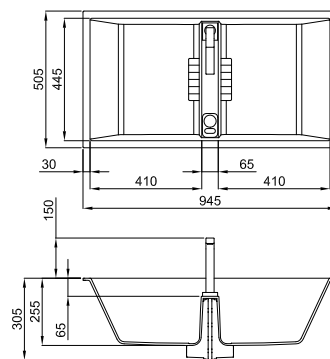

Available colours: **DOGMA 90** (see inside cover pages)

Vitrotek 3G: 96 white / 86 black

Metaltek: 79 aluminium

Granitek: 43 tortora

Technical data

Electrical network connection:
voltage 230 volt.

Maximum Absorbed Power

Electronic S.I.R. management: 15 W

Power supply services control device
with security voltage at 9 volt.

Hydraulic connection:
normal water consumption.

Connections:

Electrical: connecting wall socket.

Entering hydraulic (Hot/Cold):
normal flexible.

Exiting hydraulic (Drainer):
normal siphoning.

No adjustment and setting needed:
selfadjustment machine.





56
57



Dogma 100



Dogma 90



Suggested accessories **Dogma** collection



AVI03001
Colander

05



ACI11300
Basket

35

Resistant to violent impacts and stains.
Available only on Dogma 100 and Dogma Cromo Design.

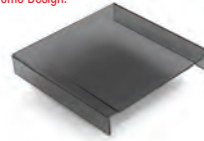

ACP05600
Lexan cover/sliding drainer

36

A richer and studied accessories outfit features our sink proposals.

For each of our model a accessories series is provided for enriching the aesthetics and functionality of our sinks.

We studied integrated systems of accessories, which exploit each of your movement.



ATL12600
Wooden chopping board

37



AKT12600
Nr. 3 wooden chopping boards

38



ATL11600
Wengè wooden chopping boards

37.1



AKT11600
Nr. 3 wengè wooden chopping boards

38.1

Mechanical and Electronic Invisio and Tevere mixers can be ordered only at the moment of Dogma 100 and 90 purchase. It is not possible to install the mixer with spout and body mixer separate after the Dogma 100 and 90 leaves the factory.

SUGGESTED MIXERS

Chrome



INVISIO electronic
code EIKINVCR

Chrome



FUSION
code MIKFUSCR

Chrome



TEVERE
code MIKTEVCR





reddot design award
honourable mention 2012

SIREX

COLLECTION

Sirex 500
two-bowl electrosink with draining area

Sirex 480
one-bowl electrosink with draining area

Sirex 475
one and half bowl electrosink with draining area

Sirex 450
two-bowl electrosink

Sirex 400
one-bowl electrosink with draining area

S.I.R. Compact Draining System



Innovative and patented compact space saving draining system that optimizes the space under the sink, due to the limited size of 5 cm. **Better exploitation and optimization of space under the sink.** Increased usable space inside the bowl because the grid, replacing the traditional waste, is laterally placed.



No hole for the overflow: more beauty with the same safety and functionality. **Greater water down flow because the grid,** replacing the traditional waste, is laterally placed.

Minimal composition, one element easy to clean. Thanks to a practical frontal panel it is possible to collect residual accidentally deposited within the **SIR** grid and make an extremely easy and precise periodical cleaning of the waste.

QUICKER AND EASIER INSTALLATION

Sirex Electrosink is supplied with premounted hooks and draining system (S.I.R.) already installed.

As a result, time saving and easier work for the installer.



95% capacity of the space underneath the sink thanks to the optimization of the bowl bottom.



Compact Draining System
Space under the sink: around 5 cm



Traditional Draining System
Space under the sink: around 30 cm

VS



ELECTRONIC OR MECHANICAL FUNCTIONING

Electronic: opening/closing activated by a button placed on the control panel. Equipped by a lithium backup battery, long lasting for a complete autonomy in case of absence of electricity.



Activating of mechanical system: popup lifting system with direct action and not rotating, much more efficient, practical and durable.



Elleci electrosinks have a **TOTAL ANTIBACTERIAL PROTECTION**, which has an adequate antibacterial coverage of the mass. In this way the bacterial organisms are repelled. Reliability and practicality become a certainty every day in the kitchen.



Technical data

Electrical network connection:
voltage 230 volt.

Maximum Absorbed Power

Electronic S.I.R. management: 9 W.

S.C.T. management
(Chromotherapy System): 20W – 12W.

Hydraulic connection:
normal water consumption.

Connections:

Electrical: connecting wall socket.

Entering hydraulic (Hot/Cold):
normal flexible.

Exiting hydraulic (Drainer):
normal siphoning.

No adjustment and setting needed:
selfadjustment machine.

Heat stop board (H.S.B.): ELLECI PATENT



H.S.B. THE PATENTED ACCESSORY INCLUDED

The HEAT STOP BOARD is supplied as accessory included in SIREX kit. It can be comfortably used as chopping board or pan stand. The space created between the H.S.B. and the drainer allows to dissipate the accumulated heat from the stainless steel board without altering the sink surface material.

62
63

Up to date, the last limit of the composite sink has been the limited resistance to high temperatures. The resistance limit tends to remain at maximum at about 250° C.

However this limit is fairly restrictive, considering that a lot of pots and pans, coffee pots, teapots, etc. may exceed it, hence the need to develop a system that does not limit such use.

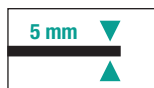

Thickness H.S.B.
AISI 316 stainless steel.

The **H.S.B.** is based on a **AISI 316** stainless steel plate application of a thickness of about **5 mm** inserted into a slot placed on the sink drainer centre, so that to make its use more practical furthermore to enable the steel plate to disperse the accumulated heat due to any contact with very hot objects, there are 4 spacer pins which create a gap between the steel plate and the composite material of the drainer surface. In this way, the accumulated heat from the plate is easily dissipated into the air. The spacers facilitate the placement of the plate on the sink keeping it blocked into its position.

In order to clean it, the removal is extremely simple and fast. Thanks to this innovation, the composite sink surpasses its last limit, while improving its visual impact due to the combination of two different materials.

1° Electrosink DUAL-MATERIAL







Sirex 500

two-bowl electrosink with draining area
 Dimension: **1160 x 515 mm**
 Built-in hole: **1140 x 495 mm**



Accessories see page 69:
05 26 27 28 39 61



Packaging:
 carton and polystyrene, m³ 0,20 approx.



Kit of the sink:
 S.I.R., heat stop board,
 premounted hooks and siphon.

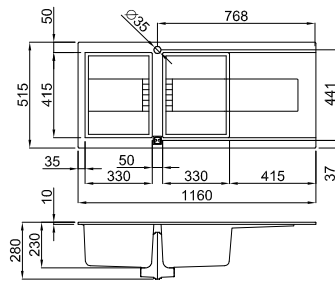

MATERIAL	SIR	CODE
Vitrotek 3G	electronic	EVI500
Metaltek	electronic	EMI500
Granitek	electronic	EGI500



MATERIAL	SIR	CODE
Vitrotek 3G	mechanical	LVI500
Metaltek	mechanical	LMI500
Granitek	mechanical	LGI500

To complete your order add the colour number chosen at the end of the code.

CODE DX: right bowl and left drainer.



Sirex 480

one-bowl electrosink with draining area
 Dimension: **1000 x 515 mm**
 Built-in hole: **980 x 495 mm**



Accessories see page 69:
05 26 27 28 39 61



Packaging:
 carton and polystyrene, m³ 0,17 approx.



Kit of the sink:
 S.I.R., heat stop board,
 premounted hooks and siphon.

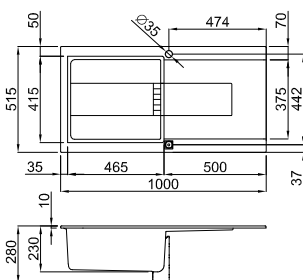

MATERIAL	SIR	CODE
Vitrotek 3G	electronic	EVI480
Metaltek	electronic	EMI480
Granitek	electronic	EGI480



MATERIAL	SIR	CODE
Vitrotek 3G	mechanical	LVI480
Metaltek	mechanical	LMI480
Granitek	mechanical	LGI480

To complete your order add the colour number chosen at the end of the code.

CODE DX: right bowl and left drainer.

Available colours: **SIREX 500/480** (see inside cover pages)

Vitrotek 3G: 97 silver - 96 white - 95 champagne - *94 ice u.s.i. - 92 old white - 90 chocolate - 86 black

Metaltek: 79 aluminium - 75 bronze (new) - 73 titanium

Granitek: 62 bianco antico - 59 antracite - 52 bianco - 51 avena - 43 tortora (new)

* (u.s.i.) until stock lasts

Sirex 475

one and half bowl electrosink with draining area

Dimension: **1000 x 515 mm**
Built-in hole: **980 x 495 mm**

Accessories see page 69:

05 26 27 28 39 61

Packaging:

carton and polystyrene, m³ 0,17 approx.

Kit of the sink:

S.I.R., heat stop board, premounted hooks and siphon.

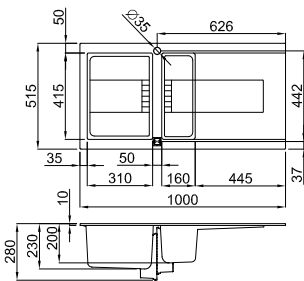

Electronic

MATERIAL	SIR	CODE
Vitrotek 3G	electronic	EVI475
Metaltek	electronic	EMI475
Granitek	electronic	EGI475



Mechanical

MATERIAL	SIR	CODE
Vitrotek 3G	mechanical	LVI475
Metaltek	mechanical	LMI475
Granitek	mechanical	LGI475

To complete your order add the colour number chosen at the end of the code.

CODE DX: right bowl and left drainer.

Sirex 450

two-bowl electrosink

Dimension: **860 x 515 mm**
Built-in hole: **840 x 495 mm**

Accessories see page 69:

05 26 27 28 39 61

Packaging:

carton and polystyrene, m³ 0,15 approx.

Kit of the sink:

S.I.R. premounted hooks and siphon.

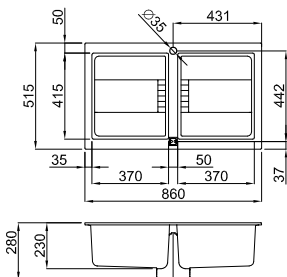

Electronic

MATERIAL	SIR	CODE
Vitrotek 3G	electronic	EVI450
Metaltek	electronic	EMI450
Granitek	electronic	EGI450



Mechanical

MATERIAL	SIR	CODE
Vitrotek 3G	mechanical	LVI450
Metaltek	mechanical	LMI450
Granitek	mechanical	LGI450

To complete your order add the colour number chosen at the end of the code.

Available colours: SIREX 475/450 (see inside cover pages)

Vitrotek 3G: 97 silver - 96 white - 95 champagne - *94 ice u.s.i. - 92 old white - 90 chocolate - 86 black

Metaltek: 79 aluminium - 73 titanium

Granitek: 62 bianco antico - 59 antracite - 52 bianco - 51 avena - 43 tortora (new)

* (u.s.i.) until stock lasts



Sirex 400

one-bowl electrosink with draining area
 Dimension: **860 x 515 mm**
 Built-in hole: **840 x 495 mm**



Accessories see page 69:
05 26 27 28 39 61



Packaging:
 carton and polystyrene, m³ 0,15 approx.



Kit of the sink:
 S.I.R., heat stop board,
 premounted hooks and siphon.



Electronic

MATERIAL	SIR	CODE
Vitrotek 3G	electronic	EVI400
Metaltek	electronic	EMI400
Granitek	electronic	EGI400



Mechanical

MATERIAL	SIR	CODE
Vitrotek 3G	mechanical	LVI400
Metaltek	mechanical	LMI400
Granitek	mechanical	LGI400

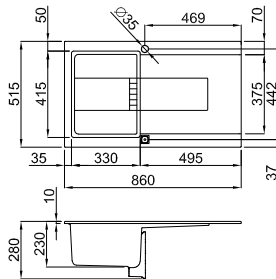

To complete your order add the colour number chosen at the end of the code.

CODE DX: right bowl and left drainer.

How to install Sirex models

N.B. In case in which the user is already in possession of worktop with standard cut-out (480 mm depth) it is needed to drill two holes in the rear mixer area and in the frontal key-board area getting a hole width of 495 mm.

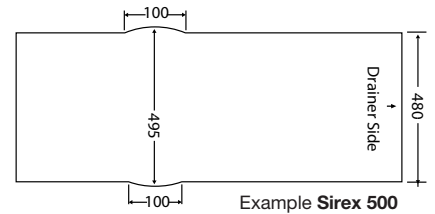

Instructions and Installing

Available colours: SIREX 400 (see inside cover pages)
Vitrotek 3G: 97 silver - 96 white - 95 champagne - *94 ice u.s.i. - 92 old white - 90 chocolate - 86 black
Metaltek: 79 aluminium - 75 bronze (new) - 73 titanium
Granitek: 62 bianco antico - 59 antracite - 52 bianco - 51 avena - 43 tortora (new)

* (u.s.i.) until stock lasts





68
69



Suggested accessories **Sirex** collection

A richer and studied accessories outfit features our sink proposals.

For each of our model a accessories series is provided for enriching the aesthetics and functionality of our sinks.

We studied integrated systems of accessories, which exploit each of your movement.



AVI03001
Colander

05



by SCHOTT
ATV01002
Sliding Glass
chopping board matt white

26



by SCHOTT
ATV01003
Sliding Glass
chopping board matt black

27



ACI01303
Basket

28



ATL01002
Wooden
chopping board

39

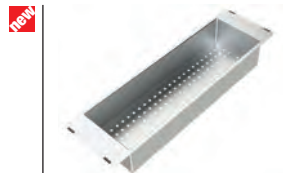

AVI03305
Colander
std L

61

SUGGESTED MIXERS

96 white



BLADE
code MVKBLA96

new

79 aluminium



ARES
code MMKARE79

96 white



ARNO LIGHT
code MVKARL96

new

Materials

For over 20 years **Elleci** has committed itself to improve its Quality, creating innovative materials for its sinks production, on the ground of eco-sustainability principles. This enables **Elleci** to put into the market high quality products so to fulfil the customers' expectations.

Our materials **Value** is the result of unending research aimed to pursue the excellence. Nowadays each upgrading has to consider the environmental respect and **Elleci** consider this aspect as a responsibility which affects every productive steps.

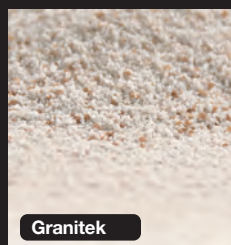
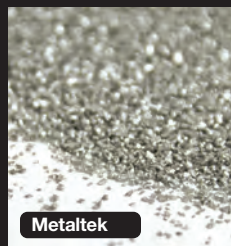
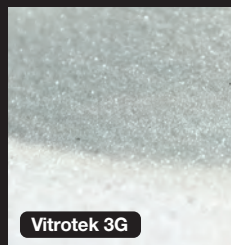

elleci materials

VITROTEK
PURE GLASS MICROSPHERES

10 Garantito
Warranty
Anni • Years

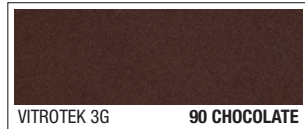
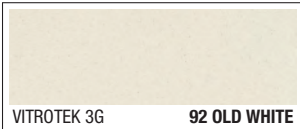
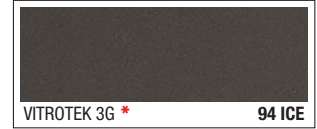
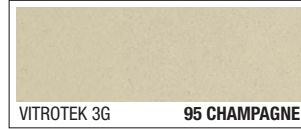
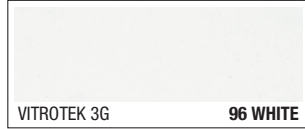

* Until stock lasts

METALTEK
GRANITE METALLIC EFFECT

10 Garantito
Warranty
Anni • Years

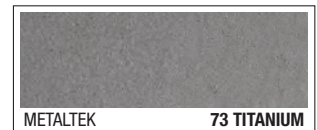
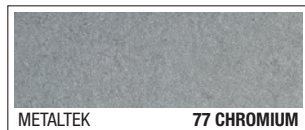
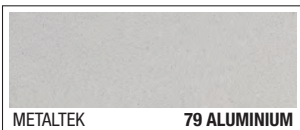

new

GRANITEK
NATURAL GRANITE EFFECT

10 Garantito
Warranty
Anni • Years

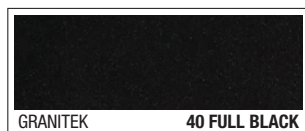
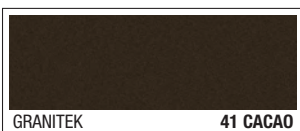
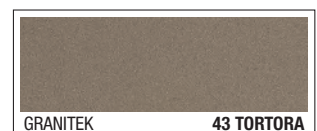
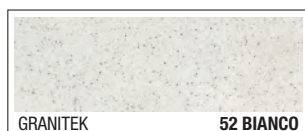
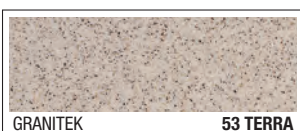
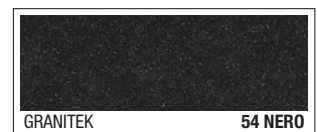
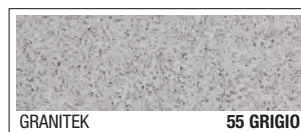
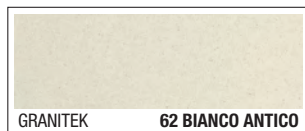

new

* Until stock lasts

G.P.S. System

G.P.S. System represents today the best moulding technology expression of thermosetting composite materials in the kitchen sinks field.

Cycle time

Chemical and physical tests show that the cycle time reduction in the manufacturing process makes the product fragile, weakening the chemical bonds of its components.

Elleci now applies in all its manufacturing processes a correct balance between productive optimization and undisputed quality of the product. Durable sinks!

Manufactured with Elleci technological system, G.P.S., sinks in Granitek, Metaltek and Vitrotek 3G are featured by an even distribution of components throughout the sink mass.

Homogeneous particles distribution of the mass sink, both on the back and front side thanks to G.P.S. production system.

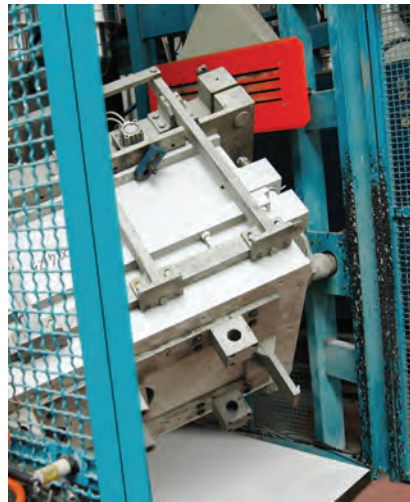

72
73

Plus of G.P.S. system:

- Improved impact resistance (+30%).
- Improved thermal shock resistance (+100%).
- Over 7000 cycles hot (above 90°C) and cold water (15°C), **20 years** of daily use.
- Better resistance to high temperatures (+30%).
- Improved appearance of the sink.



G.P.S. System:

G.P.S. system is a machines whole that allows to mould a composite material which is made up of acrylic resin filled with quartz particles of different sizes, according to the final product to be realized.

The heart of equipment is the moulding press, which represents a technologies combination that allow to get a product by mechanical properties superior to any other article of the same category.

Thanks to the fact that the press manages a dynamic mould, the machine can realize a product featured by a homogeneous distribution of the compound, even if its components have different specific weights.



Vitrotek 3G is an exclusive material composed by resin and pure glass particles. As known, the glass has specific qualities that make it an ideal element for many uses, especially in the kitchen environment. Equally hygienic are its properties. It is completely anallergic and antibacterial, resistant, hygienic, antistatic and stable in colour.

Vitrotek 3G is a material which “Sapienza” University in Rome certifies as 100% antibacterial by nature. Actually its hygiene is guaranteed from material structure and not from simple additives or surface treatments.

Compact: surface density optimized thanks to the micro spherical glass section. Easy to clean: doubled flow of liquids on its surface compared to traditional materials. Halved water absorption: using glass microspheres and hydrophobic “special resin” the water absorption is improved: 40% less than the best materials present on the market today. Consequently, bleaching resistance and surface porosity are further enhanced.

Antibacterial: extremely smooth surface. **Nonporous, hydrophobic and lipophobic.** Impossible the bacteria establishment.

Improved hardness of the surface maintained unchanged: initial unchanged qualities thanks to the extremely compact surface.

100% pure glass microspheres.

100% antibacterial protection.

Hydrophobic: it repulses water.

Lipophobic: it repulses greases.

Compact: extremely smooth and hard surface.

Improved resistance to thermal shocks.

Doubled flow of liquids.

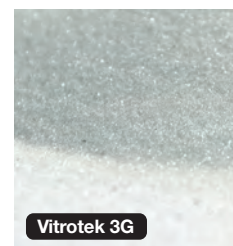

METALTEK
GRANITE METALLIC EFFECT

10 Garantito
Warranty
Anni • Years

It attracts the eye, inviting to the touch. Aesthetical impact, adaptability to steel, Granitek functionality and practicality.



The chemical composition is made up natural granite, acrylic resin and, like all the sinks manufactured with the technological leadership G.P.S. system, has an even mass resulting in high resistance to stains, impact and temperature changes.

The uniqueness of this product is that have been added the metal particles, making the product with a brilliant and shining finish. The target is to obtain special “metallic effects”.

The different finishes allow a perfect match between the sink and the other stainless steel components in the kitchen.



ANTIBACTERIAL PROTECTION

The **Metaltek** material has an antibacterial protection, which has an adequate antibacterial coverage of the mass. In this way the bacterial organisms are repelled. The mass is in fact enriched with silver ions that inhibit the establishment and growth of bacteria.

74
75

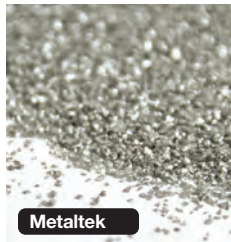



Granitek is given by the union of natural granite and acrylic resin and has the best quality: high resistance of granite to high temperatures, to impacts and to the most violent shocks. Appearance like a natural stone.

Ceramization: is a specific colouring process of the granite particle. The painting is not only on the surface but in the entire mass of the particle through a firing process at 700°C which allows to penetrate into the particle nucleus.

ELLECI CERAMIZED PARTICLE



NOT CERAMIZED PARTICLE



The result is a significant improvement in resistance to the discoloration.

The coloured granite selection, variation and shades combination determine the finished product colour.

ANTIBACTERIAL PROTECTION

The **Granitek** material has an antibacterial protection, which has an adequate antibacterial coverage of the mass. In this way the bacterial organisms are repelled. The mass is in fact enriched with silver ions that inhibit the establishment and growth of bacteria.

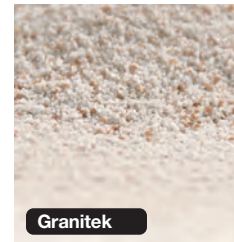



SMART

COLLECTION

Smart 500
two-bowl sink with draining area

Smart 480
one-bowl sink with draining area

Smart 475
one and half bowl sink with draining area

Smart 450
two-bowl sink

Smart 400
one-bowl sink with draining area

Design plus functionality



Smart is the composite sinks collection with flat aesthetic that see, for the first time, the installation of the innovative compact draining system S.I.R. SMART.

ELLECI PATENT



SMART

MANUAL SPACE SAVING CLOSING

DESIGN OVERFLOW ONE PER SINK-BOWL:

Increased overflow in smart position for lower water consumption: **Smart** and **Green**.

MORE QUICK AND EASY INSTALLATION:

Smart sink is provided with pre-mounted hooks and S.I.R. SMART draining system already tested and installed. It means a considerable time-saving and facility for the installer.



Overflow **SMART**



S.I.R. Smart - One overflow per sink-bowl



Space saving grid



Compact Draining System



Compact Draining System
Under the sink: around 5 cm



Standard Draining System
Under the sink: around 30 cm

VS



Inset:

The rim of the sink after installation appears on the worktop.



Elleci sinks have a **TOTAL ANTIBACTERIAL PROTECTION**, which has an adequate antibacterial coverage of the mass. In this way the bacterial organisms are repelled. Reliability and practicality become a certainty every day in the kitchen.



SCAR



SMART

Nr. 2 overflows

Smart 500

two-bowl sink with draining area
Dimension: **1160 x 515 mm**
Built-in hole: **1140 x 480 mm**

new

MATERIAL	CODE
Vitrotek 3G	LVI500__SMT
Metaltek	LMI500__SMT
Granitek	LGI500__SMT



To complete your order add the colour number chosen instead of dashes.

Accessories see page 83:

05 26 27 28 39 61

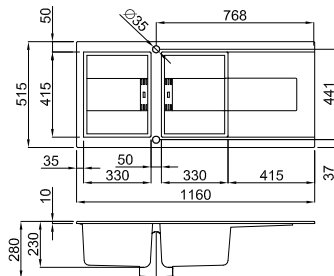

Packaging:
carton and polystyrene, m³ 0,20 approx.

Kit of the sink:
installed S.I.R.
premounted hooks and siphon.

80
81



SMART

Smart 480

one-bowl sink with draining area
Dimension: **1000 x 515 mm**
Built-in hole: **980 x 480 mm**

new

MATERIAL	CODE
Vitrotek 3G	LVI480__SMT
Metaltek	LMI480__SMT
Granitek	LGI480__SMT



To complete your order add the colour number chosen instead of dashes.

Accessories see page 83:

05 26 27 28 39 61

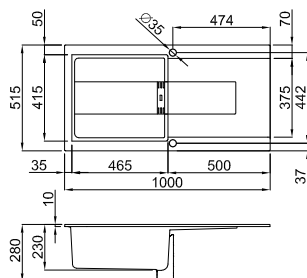

Packaging:
carton and polystyrene, m³ 0,17 approx.

Kit of the sink:
installed S.I.R.
premounted hooks and siphon.

Available colours: SMART 500/480 (see inside cover pages)

Vitrotek 3G: 97 silver - 96 white - 95 champagne - 92 old white - 90 chocolate - 86 black

Metaltek: 79 aluminium - 75 bronze (new) - 73 titanium

Granitek: 62 bianco antico - 59 antracite - 52 bianco - 51 avena - 43 tortora (new)

Smart 475

NEW

one and half bowl sink with draining area

Dimension: **1000 x 515 mm**
Built-in hole: **980 x 480 mm**

MATERIAL	CODE
Vitrotek 3G	LVI475__SMT
Metaltek	LMI475__SMT
Granitek	LGI475__SMT



SMART

Nr. 2
overflows

To complete your order add the colour number chosen instead of dashes.

Accessories see page 83:

05 26 27 28 39 61

Packaging:

carton and polystyrene, m³ 0,17 approx.

Kit of the sink:

installed S.I.R.
premounted hooks and siphon.

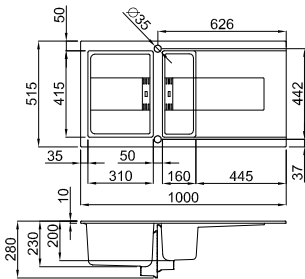

Smart 450

NEW

two-bowl sink

Dimension: **860 x 515 mm**
Built-in hole: **840 x 480 mm**

MATERIAL	CODE
Vitrotek 3G	LVI450__SMT
Metaltek	LMI450__SMT
Granitek	LGI450__SMT



SMART

Nr. 2
overflows

To complete your order add the colour number chosen instead of dashes.

Accessories see page 83:

05 26 27 28 39 61

Packaging:

carton and polystyrene, m³ 0,15 approx.

Kit of the sink:

installed S.I.R.
premounted hooks and siphon.

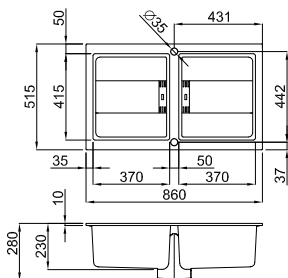

Available colours: **SMART 475/450** (see inside cover pages)

Vitrotek 3G: 97 silver - 96 white - 95 champagne - 90 chocolate - 86 black

Metaltek: 79 aluminium - 73 titanium

Granitek: 62 bianco antico - 59 antracite - 52 bianco - 51 avena - 43 tortora (new)



Smart 400

one-bowl sink with draining area
 Dimension: **860 x 515 mm**
 Built-in hole: **840 x 480 mm**

new



MATERIAL	CODE
Vitrotek 3G	LVI400__SMT
Metaltek	LMI400__SMT
Granitek	LGI400__SMT

To complete your order add the colour number chosen instead of dashes.

Accessories see page 83:

05 26 27 28 39 61

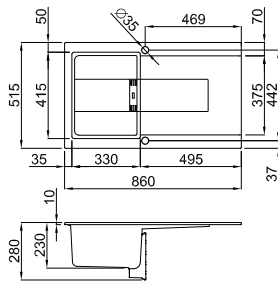

Packaging:
 carton and polystyrene, m³ 0,15 approx.

Kit of the sink:
 installed S.I.R.
 premounted hooks and siphon.

Available colours: SMART 400 (see inside cover pages)
Vitrotek 3G: 97 silver - 96 white - 95 champagne - 92 old white
 90 chocolate - 86 black
Metaltek: 79 aluminium - 75 bronze (new) - 73 titanium
Granitek: 62 bianco antico - 59 antracite - 52 bianco - 51 avena - 43 tortora (new)



Suggested accessories **Smart** collection

A richer and studied accessories outfit features our sink proposals.

For each of our model a accessories series is provided for enriching the aesthetics and functionality of our sinks.

We studied integrated systems of accessories, which exploit each of your movement.



AVI03001
Colander

05

by SCHOTT



ATV01002
Sliding Glass
chopping board matt white

26

by SCHOTT



ATV01003
Sliding Glass
chopping board matt black

27



ACI01303
Basket

28



ATL01002
Wooden
chopping board

39

new



AVI03305
Colander
std L

61



SUGGESTED MIXERS

96 white



JUST PLUS
code MVKJUP96

new

79 aluminium



BLADE
code MMKBLA79

new

96 white



ARES
code MVKARE96



VALUE

COLLECTION

Value 130 INSET
one-bowl sink

Value 130 UNDERMOUNT
one-bowl sink

Arranging, hiding and modelling the Water Zone have never been so simple and pleasant.

An essential project inspired by an unique, timeless concept.

Unique products featured by a marked innovative character which blends the extreme functionality with the ability to “model itself” to the user requirements up to completely disappear.

FUNCTIONALITY

Guides placed along the whole sink which allow to integrate a lot of accessories.



Prisma-Clean:
prismatic edge sinks.

II PRISMA-CLEAN: prismatic radius born by softness of a curve.

Prismatic section corners tend to blend those particular points difficult to reach and to clean together with a soft shape, even if marking the sink by straight and sharp lines. The result is a look by an extraordinary visual impact and marked innovative side.

86
87

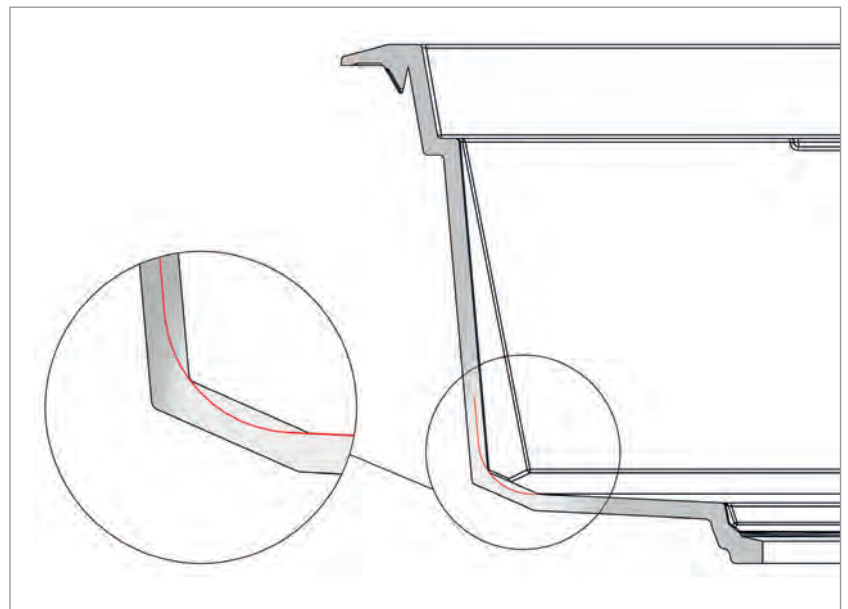
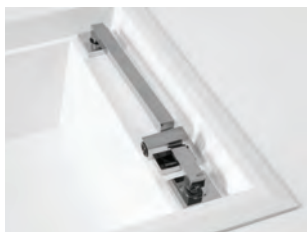

EXCLUSIVE AND COORDINATED DESIGN

In itself design contributes to make this product userfriendly. Up to now the modern shapes have been characterized by a clean design and minimal radius while those classical by wide radius. Value Collection is featured by an exclusive design, modern style and in the meanwhile by an extremely cleaning easiness thanks to the ample radius.

ACCESSORIES AREA

Exclusive suitable components (overflow, pop-up waste, staves and e-cover). Technological components. Modular accessories: with sink they create a WATERZONE which allows to separate and optimize the spaces according to the operations connected to water (PREPARING, CLEANING, COOKING). Exclusive accessories in terms of shapes and materials.

COORDINATED DESIGN

Multifunctional areas from both sides. Preholed area which allows to install a large accessories range: pop-up waste, pullout shower mixer, compact soap dispenser and foldaway modular staves.



Elleci sinks have a **TOTAL ANTIBACTERIAL PROTECTION**, which has an adequate antibacterial coverage of the mass. In this way the bacterial organisms are repelled. Reliability and practicality become a certainty every day in the kitchen.





Inset



Prisma Clean

Value 130 inset

one-bowl sink

Dimension: **770 x 500** mm
Built-in hole: **750 x 480** mm

MATERIAL	CODE
Vitrotek 3G	LVV130
Metaltek	LMV130
Granitek	LGV130



To complete your order add the colour number chosen at the end of the code.

Accessories see page 93:

42 50 51 52 55 56 145

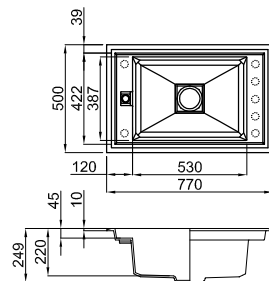

Packaging:

carton and polystyrene, m³ 0,14 approx.

Kit of the sink:

space-saving siphon, waste and pre-mounted hooks.
Waste cover and overflow in composite material (Vitrotek 3G, Metaltek or Granitek).



Undermount



Prisma Clean

Value 130 undermount

one-bowl sink

Dimension: **724 x 454** mm
Built-in hole: **695 x 425** mm

MATERIAL	CODE
Vitrotek 3G	LVV130__BSO
Metaltek	LMV130__BSO
Granitek	LGV130__BSO



To complete your order add the colour number chosen instead of dashes.

Accessories see page 93:

42 50 51 52 56 145

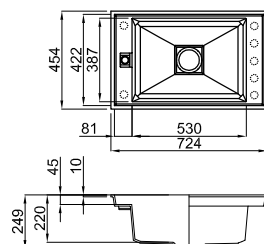

Packaging:

carton and polystyrene, m³ 0,13 approx.

Kit of the sink:

space-saving siphon, waste and pre-mounted hooks.
Waste cover and overflow in composite material (Vitrotek 3G, Metaltek or Granitek).

Available colours: VALUE (see inside cover pages)

Vitrotek 3G: 97 silver - 96 white - 95 champagne - 90 chocolate - 86 black

Metaltek: 79 aluminium - 77 chromium - 73 titanium (new) - 70 ghisa

Granitek: 62 bianco antico - 59 antracite - 52 bianco - 51 avena - 43 tortora (new)



inset



undermount

Each detail and accessory have been designed for harmoniously living in a multifunctional environment.

FOLDAWAY OVERFLOW realized in the same material.

FOLDWAY WASTE

Waste and overflow are for the first time integrated in the Water Zone thanks to the cover manufactured in the same material.



- 1 ONE - MATERIAL
- 2 PRISMATIC EDGES
- 3 FOLDAWAY MIXER FOR UNDER WINDOW INSTALLATION

FUSION

Suitably researched foldaway mixers featured by a clean and practical design. Foldaway with E-COVER.



Under-window sink

Pull-out shower with onboard control, an even more professional and practical use.



Close and replace



Multifunctional foldaway top. Guides placed along the whole sink which allow to integrate a lot of accessories.

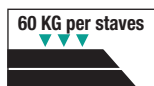

STAVES IN VITROTEK 3G, METALTEK E GRANITEK

Innovative staves system which constitutes a multifunctional, modular working top and for the first time manufactured with the same material which the sink is made of. (supported weight: 60 kg per staves).

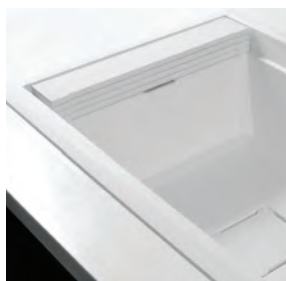

New Version

Manufactured with 2 mm thick AISI 304 stainless steel plates and with food-grade silicone, resistant to high temperatures (up to 180° C).

E-Cover an innovative accessory.

- Core in AISI stainless steel (2 mm thickness)
- Covered with heat-resistant food silicone
- Simple removal for cleaning
- When opened it becomes a functional and safe back support that avoids water leakage
- Folding points in high-resistant food silicone guarantee an intensive use of this product for thousands of cycles.

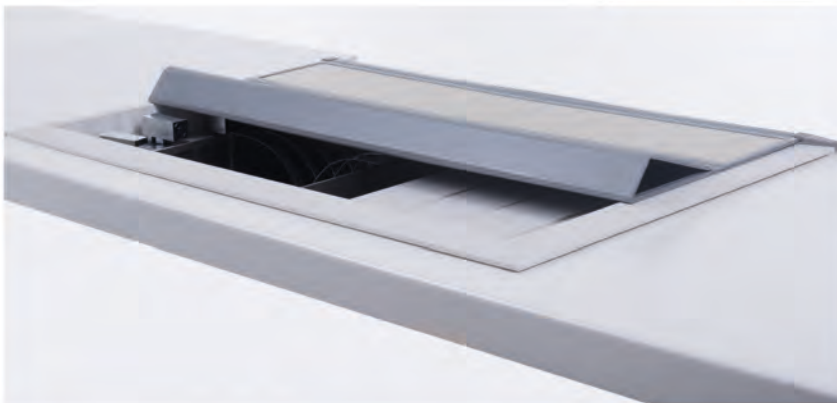
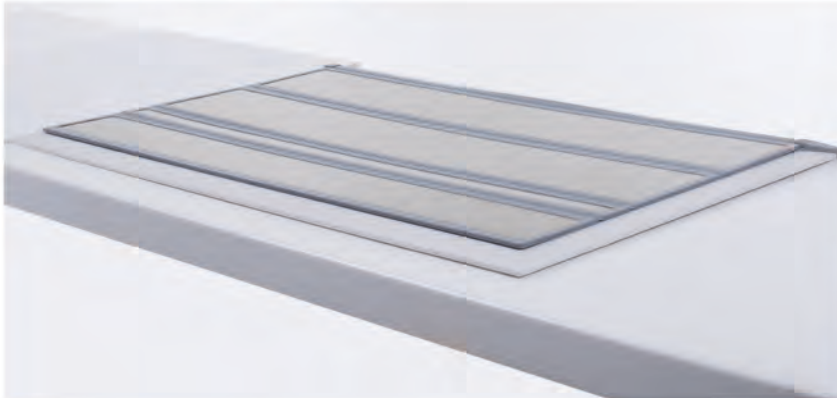

When closed it becomes a totally usable working top, resistant up to 180 °C

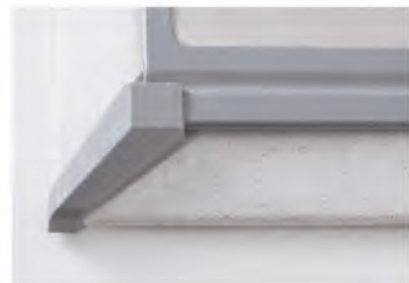

Comfortable fixing system on the sink

*Available only on standard models (not undermounted)



92
93



Suggested accessories **Value** collection

A richer and studied accessories outfit features our sink proposals.

For each of our model a accessories series is provided for enriching the aesthetics and functionality of our sinks.

We studied integrated systems of accessories, which exploit each of your movement.



ARI01300
Rollmat

42



ADI02301
Compact and squared soap dispenser (H. 40 mm)

50

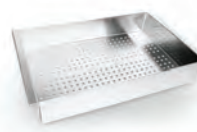

AVI03303
Colander
Value

51



ADI01301
Flat drainer
Value

52



Colander and Drainer

51

+

52



AKD013_ (color number)
Nr. 4 staves in composite material Value 130

56



ASP17000
Pop-up waste 1 way - 3,5" round strainer plug and cube control knob Value

145

The waste drain equipped with a foldaway popup system. It does not lift the grid, allowing a collection of all the rubbish: **NO MORE CLOGGED PIPES.**

new



ACA01300
Value 130 stainless steel and food silicone E-cover

55

SUGGESTED MIXERS

Chrome



FUSION PLUS
code MIKFUPCR

Chrome



FUSION
code MIKFUSCR

73 titanium



ARES
code MMKARE73



KARISMA

COLLECTION

Karisma 120 INSET
one-bowl sink

Karisma 120 UNDERMOUNT
one-bowl sink

Karisma 105 INSET
one-bowl sink

Karisma 105 UNDERMOUNT
one-bowl sink

Charismatic design.

K

“Flared” edge which calls for a more harmonious use of the sink. Despite keeping straight and sharp lines, design is present for giving functionality and comfort.

The 45° rounding off, which connects the edge and the bowl, makes easier the PREPARING, CLEANING and COOKING operations in the Water Zone, besides giving a highly innovative look.



K Edge:
45° rounding off.



Installing the Karisma innovative sink into under-top version the final result is a highly aesthetical impact different from all the squared sinks up to now realized.



Inset:

The rim of the sink after installation appears on the worktop.



Undermount:

The rim of the sink appears underneath the worktop.



ACCESSORIES AREA

The generous technical area of 70 mm allows to place a wide accessories range giving a wide customization freedom. All is integrated in a total coordinating concept completed by squared waste drain.



Elleci sinks have a **TOTAL ANTIBACTERIAL PROTECTION**, which has an adequate antibacterial coverage of the mass. In this way the bacterial organisms are repelled. Reliability and practicality become a certainty every day in the kitchen.





Karisma 120 inset

one-bowl sink

Dimension: **700 x 500 mm**
Built-in hole: **680 x 480 mm**



Inset



K Edge

MATERIAL	CODE
Vitrotek 3G	LVK120__BTP
Metatek	LMK120__BTP
Granitek	LGK120__BTP

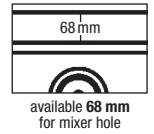

To complete your order add the colour number chosen instead of dashes.

Accessories see page 103:

05 09 24 25 28 50 54 68 144

Packaging:

carton and polystyrene, m³ 0,13 approx.

Kit of the sink:

space-saving siphon, square waste and pre-mounted hooks.

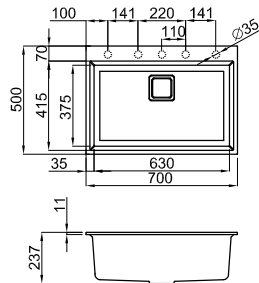

Karisma 105 inset

one-bowl sink

Dimension: **570 x 500 mm**
Built-in hole: **550 x 480 mm**



Inset



K Edge

MATERIAL	CODE
Vitrotek 3G	LVK105
Metatek	LMK105
Granitek	LGK105



To complete your order add the colour number chosen at the end of the code.

Accessories see page 103:

05 09 24 25 28 50 54 67 144

Packaging:

carton and polystyrene, m³ 0,11 approx.

Kit of the sink:

space-saving siphon, square waste and pre-mounted hooks.

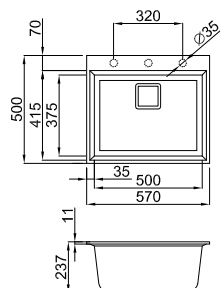

Available colours: **KARISMA inset 120/105** (see inside cover pages)

Vitrotek 3G: 97 silver - 96 white - 95 champagne - 92 old white - 90 chocolate - 86 black

Metatek: 79 aluminium - 77 chromium - 73 titanium - 70 ghisa

Granitek: 68 bianco titano - 62 bianco antico - 59 antracite - 55 grigio - 54 nero - 53 terra - 52 bianco - 51 avena
43 tortora (new) - 41 cacao





Karisma 120 undermount

one-bowl sink

Dimension: **700 x 447 mm**
Built-in hole: **664 x 411 mm - R5**



Undermount



K Edge

MATERIAL	CODE
Vitrotek 3G	LVK120__BSC
Metaltek	LMK120__BSC
Granitek	LGK120__BSC



To complete your order add the colour number chosen instead of dashes.

Accessories see page 103:

09 28 54 68

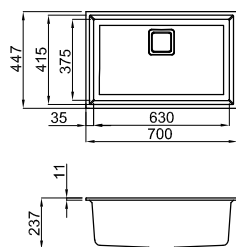

Packaging:
carton and polystyrene, m³ 0,13 approx.

Kit of the sink:
space-saving siphon, square waste and pre-mounted hooks.

100
101



Karisma 105 undermount

one-bowl sink

Dimension: **570 x 450 mm**
Built-in hole: **534 x 411 mm - R5**



Undermount



K Edge

MATERIAL	CODE
Vitrotek 3G	LVK105__BSO
Metaltek	LMK105__BSO
Granitek	LGK105__BSO



To complete your order add the colour number chosen instead of dashes.

Accessories see page 103:

09 28 54 67

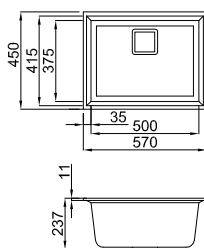

Packaging:
carton and polystyrene, m³ 0,11 approx.

Kit of the sink:
space-saving siphon, square waste and pre-mounted hooks.

Available colours: **KARISMA undermount 120/105** (see inside cover pages)

Vitrotek 3G: 97 silver - 96 white - 95 champagne - 92 old white - 90 chocolate - 86 black

Metaltek: 79 aluminium - 77 chromium - 73 titanium - 70 ghisa

Granitek: 68 bianco titano - 62 bianco antico - 59 antracite - 55 grigio - 54 nero - 53 terra - 52 bianco - 51 avena
43 tortora (new) - 41 cacao



GK-MK-VK Sinks



102
103

Suggested accessories **Karisma** collection

A richer and studied accessories outfit features our sink proposals.

For each of our model a accessories series is provided for enriching the aesthetics and functionality of our sinks.

We studied integrated systems of accessories, which exploit each of your movement.



AVI03001
Colander

05



ADI01300
Dish drainer

09



by SCHOTT
ATV01001
Glass sliding chopping board

24



ADI02300
Round soap dispenser

25



ACI01303
Basket

28



ADI02301
Compact and squared soap dispenser (H. 40 mm)

50



ATQ01300
Squared food waste disposer flange

54

new

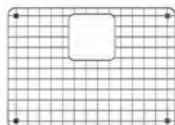

AGB01304
Bottom grid M

67

new

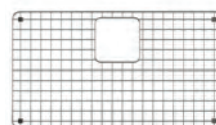

AGB01303
Bottom grid L

68



ASP16300
Pop-up waste 1 way - 3,5" square strainer plug and control knob for Karisma collection

144

SUGGESTED MIXERS

Chrome



INVISO electronic
code EIKINVCR

86 black



STREAM PLUS
code MVKSTP86

new

90 chocolate



ARES
code MVKARE90

104
105



QUADRA

COLLECTION



inset

Quadra 350 INSET
two-bowl sink

Quadra 150 INSET
two-bowl sink

Quadra 130 INSET
one-bowl sink

Quadra 110 INSET
one-bowl sink

Quadra 105 INSET
one-bowl sink

Quadra 100 INSET
one-bowl sink

Quadra 50 INSET
one-bowl sink

Quadra 200 INSET
two-bowl sink

Quadra 210 INSET
two-bowl sink



Undermount

Quadra 350 UNDERMOUNT
two-bowl sink

Quadra 150 UNDERMOUNT
two-bowl sink

Quadra 130 UNDERMOUNT
one-bowl sink

Quadra 110 UNDERMOUNT
one-bowl sink

Quadra 105 UNDERMOUNT
one-bowl sink

Quadra 100 UNDERMOUNT
one-bowl sink

Quadra 50 UNDERMOUNT
one-bowl sink

Quadra 200 UNDERMOUNT
two-bowl sink

Quadra 210 UNDERMOUNT
two-bowl sink

Quadra Standard: minimal design and contemporary style.

A minimal sinks collection which, due to its simplicity, succeeds to highlight its moderns and clean shapes. Each model can be equipped with many accessories and the many colours.



106
107



Inset:

The rim of the sink after installation appears on the worktop.



New accessory: waste cover.

- SPACE-SAVING SIPHON
- OVERFLOW ELLECI
- PRE-MOUNTED HOOKS



Elleci sinks have a **TOTAL ANTIBACTERIAL PROTECTION**, which has an adequate antibacterial coverage of the mass. In this way the bacterial organisms are repelled. Reliability and practicality become a certainty every day in the kitchen.



Quadra 350 inset

two-bowl sink

Dimension: 790 x 500 mm

Built-in hole: 760 x 480 mm

MATERIAL	CODE
Vitrotek 3G	LVQ350
Metaltek	LMQ350
Granitek	LGQ350

*Available from the end of November

To complete your order add the colour number chosen at the end of the code.

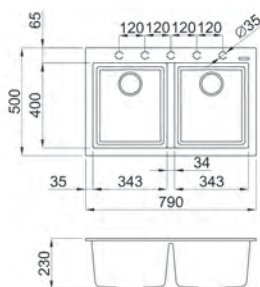

Accessories see page 119:

04 05 09 24 25 50 61 141 142 143 146 147

Packaging:

carton and polystyrene, m³ 0,13 approx.

Kit of the sink:

space-saving siphon, wastes and pre-mounted hooks.

Available colours: **QUADRA inset 350** (see inside cover pages)

Vitrotek 3G: 97 silver - 96 white - 95 champagne - 92 old white - 90 chocolate - 86 black

Metaltek: 79 aluminium - 77 chromium - 73 titanium - 70 ghisa

Granitek: 68 bianco titano - 62 bianco antico - 59 antracite - 55 grigio - 54 nero - 53 terra - 52 bianco - 51 avena

43 tortora (new) - 41 cacao - 40 full black (new)



Quadra 150 inset

two-bowl sink

Dimension: **590 x 500 mm**
Built-in hole: **575 x 480 mm**



Inset

MATERIAL	CODE
Vitrotek 3G	LVQ150
Metaltek	LMQ150
Granitek	LGQ150

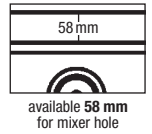

available 58 mm for mixer hole

To complete your order add the colour number chosen at the end of the code.

Accessories see page 119:

04 05 06 09 17 24 25 50 61 66 141 142 143 146 147

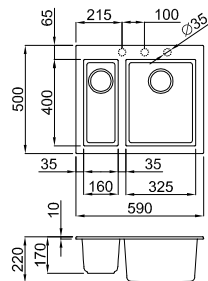

Packaging:

carton and polystyrene, m³ 0,10 approx.

Kit of the sink:

space-saving siphon, wastes and pre-mounted hooks.

108
109



Quadra 130 inset

one-bowl sink

Dimension: **790 x 500 mm**
Built-in hole: **770 x 480 mm**



Inset

MATERIAL	CODE
Vitrotek 3G	LVQ130
Metaltek	LMQ130
Granitek	LGQ130

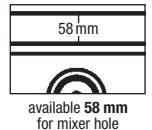

available 58 mm for mixer hole

To complete your order add the colour number chosen at the end of the code.

Accessories see page 119:

04 05 06 09 17 24 25 50 61 68 141 142 143 146 147

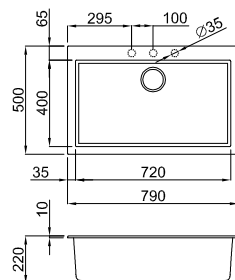

Packaging:

carton and polystyrene, m³ 0,13 approx.

Kit of the sink:

space-saving siphon, wastes and pre-mounted hooks.

Available colours: **QUADRA inset 150/130** (see inside cover pages)

Vitrotek 3G: 97 silver - 96 white - 95 champagne - *94 ice u.s.l. - 92 old white - 90 chocolate - 86 black

Metaltek: 79 aluminium - 77 chromium - 73 titanium - *71 alluminio u.s.l. - 70 ghisa

Granitek: 68 bianco titano - 62 bianco antico - 59 antracite - 55 grigio - 54 nero - 53 terra - 52 bianco - 51 avena 43 tortora (new) - 41 cacao - 40 full black (new)

* (u.s.l.) until stock lasts

Quadra 110 inset

one-bowl sink

Dimension: **610 x 500 mm**
Built-in hole: **590 x 480 mm**

MATERIAL	CODE
Vitrotek 3G	LVQ110
Metaltek	LMQ110
Granitek	LGQ110

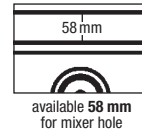

To complete your order add the colour number chosen at the end of the code.

Accessories see page 119:

04 05 06 09 17 24 25 50 61 67 141 142 143 146 147

Packaging:

carton and polystyrene, m³ 0,11 approx.

Kit of the sink:

space-saving siphon,
wastes and pre-mounted hooks.

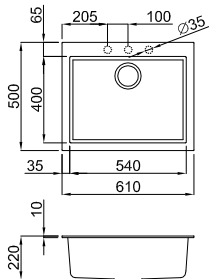

Quadra 105 inset

one-bowl sink

Dimension: **570 x 500 mm**
Built-in hole: **550 x 480 mm**

MATERIAL	CODE
Vitrotek 3G	LVQ105
Metaltek	LMQ105
Granitek	LGQ105

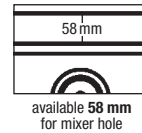

To complete your order add the colour number chosen at the end of the code.

Accessories see page 119:

04 05 06 09 17 24 25 50 61 67 141 142 143 146 147

Packaging:

carton and polystyrene, m³ 0,11 approx.

Kit of the sink:

space-saving siphon,
wastes and pre-mounted hooks.

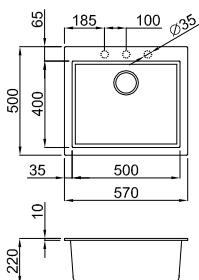

Available colours: **QUADRA inset 110/105** (see inside cover pages)

Vitrotek 3G: 97 silver - 96 white - 95 champagne - *94 ice u.s.l. - 92 old white - 90 chocolate - 86 black

Metaltek: 79 aluminium - 77 chromium - 73 titanium - *71 alluminio u.s.l. - 70 ghisa

Granitek: 68 bianco titano - 62 bianco antico - 59 antracite - 55 grigio - 54 nero - 53 terra - 52 bianco - 51 arena
43 tortora (new) - 41 cacao - 40 full black (new)

* (u.s.l.) until stock lasts



Quadra 100 inset

one-bowl sink

Dimension: **410 x 500** mm
Built-in hole: **390 x 480** mm



Inset

MATERIAL	CODE
Vitrotek 3G	LVQ100
Metaltek	LMQ100
Granitek	LGQ100

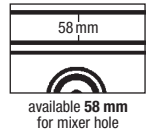

available **58 mm**
for mixer hole

To complete your order add the colour number chosen at the end of the code.

Accessories see page 119:

04 05 06 09 17 24 25 50 61 66 141 142 143 146 147

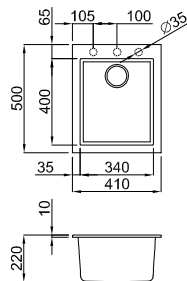

Packaging:

carton and polystyrene, m³ 0,07 approx.

Kit of the sink:

space-saving siphon,
wastes and pre-mounted hooks.

110
111



Quadra 50 inset

one-bowl sink

Dimension: **230 x 500** mm
Built-in hole: **215 x 480** mm



Inset

MATERIAL	CODE
Vitrotek 3G	LVQ050
Metaltek	LMQ050
Granitek	LGQ050

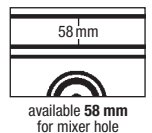

available **58 mm**
for mixer hole

To complete your order add the colour number chosen at the end of the code.

Accessories see page 119:

05 09 142 146 147

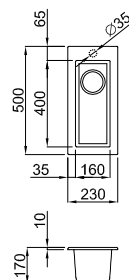

Packaging:

carton and polystyrene, m³ 0,04 approx.

Kit of the sink:

space-saving siphon,
wastes and pre-mounted hooks.

Available colours: **QUADRA inset 100/50** (see inside cover pages)

Vitrotek 3G: 97 silver - 96 white - 95 champagne - *94 ice u.s.l. - 92 old white - *91 jada u.s.l. - 90 chocolate - 86 black

Metaltek: 79 aluminium - 77 chromium - 73 titanium - 70 ghisa

Granitek: 68 bianco titano - 62 bianco antico - 59 antracite - 55 grigio - 54 nero - 53 terra - 52 bianco - 51 avena

43 tortora (new) - 41 cacao - 40 full black (new)

* (u.s.l.) until stock lasts

Quadra 200 inset

two-bowl sink

Dimension: **410 x 500 mm**
+ **410 x 500 mm**

MATERIAL	CODE
Vitrotek 3G	LVQ200
Metaltek	LMQ200
Granitek	LGQ200



To complete your order add the colour number chosen at the end of the code.

Accessories see page 119:

04 05 06 09 17 24 25 50 61 66 141 142 143 146 147

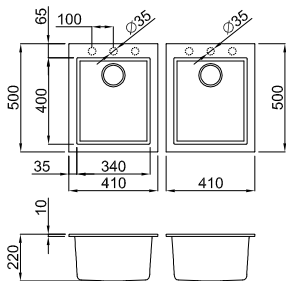

Packaging:
carton and polystyrene, m³ 0,13 approx.

Kit of the sink:
space-saving siphon,
wastes and pre-mounted hooks.

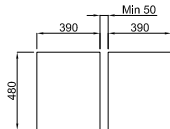

Built-in hole:



66

AGB01305
Bottom grid M

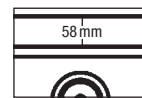

available **58 mm**
for mixer hole

Quadra 210 inset

two-bowl sink

Dimension: **610 x 500 mm**
+ **410 x 500 mm**

MATERIAL	CODE
Vitrotek 3G	LVQ210
Metaltek	LMQ210
Granitek	LGQ210

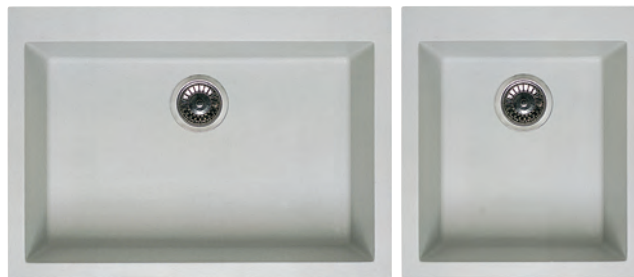

To complete your order add the colour number chosen at the end of the code.

Accessories see page 119:

04 05 06 09 17 24 25 50 61 66 67 141 142 143 146 147

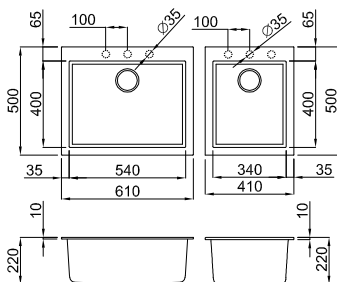

Packaging:
carton and polystyrene, m³ 0,13 approx.

Kit of the sink:
space-saving siphon,
wastes and pre-mounted hooks.

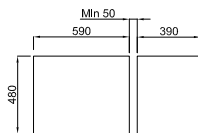

Built-in hole:



66

AGB01305
Bottom grid M

67

AGB01304
Bottom grid M

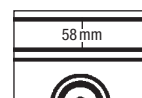

available **58 mm**
for mixer hole

Available colours: **QUADRA inset 200/210** (see inside cover pages)

Vitrotek 3G: 97 silver - 96 white - 95 champagne - 92 old white - 90 chocolate - 86 black

Metaltek: 79 aluminium - 77 chromium - 73 titanium - 70 ghisa

Granitek: 68 bianco titano - 62 bianco antico - 59 antracite - 55 grigio - 54 nero - 53 terra - 52 bianco - 51 avena

43 tortora (new) - 41 cacao - 40 full black (new)

Quadra
Under mounted:
when creativity
meets
functionality.

This sinks collection has been designed having in mind the utmost optimization of the kitchen working top.



112
113



Undermount:

The rim of the sink appears underneath the worktop.



Accessory: square waste.

- SPACE-SAVING SIPHON
- OVERFLOW ELLECI
- PRE-MOUNTED HOOKS



Elleci sinks have a **TOTAL ANTIBACTERIAL PROTECTION**, which has an adequate antibacterial coverage of the mass. In this way the bacterial organisms are repelled. Reliability and practicality become a certainty every day in the kitchen.



Quadra 350 inset

two-bowl sink

Dimension: 756 x 430 mm

Built-in hole: 715 x 390 mm

MATERIAL	CODE
Vitrotek 3G	LVQ350_BSO
Metaltek	LMQ350_BSO
Granitek	LGQ350_BSO



*Available from the end of November

To complete your order add the colour number chosen at the end of the code.

Accessories see page 119:

04 05 09 24 25 50 61 141 142 143 146 147

Packaging:

carton and polystyrene, m³ 0,13 approx.

Kit of the sink:

space-saving siphon, wastes and pre-mounted hooks.

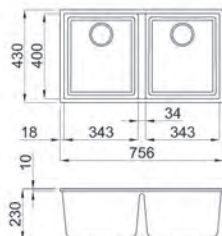

Available colours: **QUADRA undermount 350** (see inside cover pages)

Vitrotek 3G: 97 silver - 96 white - 95 champagne - 92 old white - 90 chocolate - 86 black

Metaltek: 79 aluminium - 77 chromium - 73 titanium - 70 ghisa

Granitek: 68 bianco titano - 62 bianco antico - 59 antracite - 55 grigio - 54 nero - 53 terra - 52 bianco - 51 avena

43 tortora (new) - 41 cacao - 40 full black (new)



Quadra 150 undermount

two-bowl sink

Dimension: **560 x 440 mm**
Built-in hole: **520 x 400 mm**



MATERIAL	CODE
Vitrotek 3G	LVQ150__BSO
Metaltek	LMQ150__BSO
Granitek	LGQ150__BSO

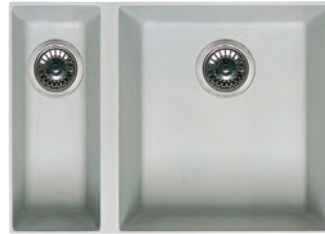

To complete your order add the colour number chosen instead of dashes.

Accessories see page 119:

06 09 17 61 66 142 146

Packaging:

carton and polystyrene, m³ 0,10 approx.

Kit of the sink:

space-saving siphon, wastes and undermounted kit.

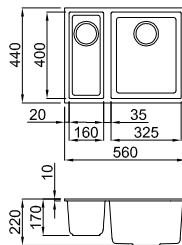

114
115



Quadra 130 undermount

one-bowl sink

Dimension: **760 x 440 mm**
Built-in hole: **720 x 400 mm**



MATERIAL	CODE
Vitrotek 3G	LVQ130__BSO
Metaltek	LMQ130__BSO
Granitek	LGQ130__BSO



To complete your order add the colour number chosen instead of dashes.

Accessories see page 119:

06 09 17 61 68 142 146

Packaging:

carton and polystyrene, m³ 0,13 approx.

Kit of the sink:

space-saving siphon, wastes and undermounted kit.

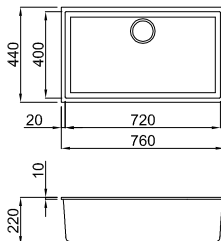

Available colours: **QUADRA undermount 150/130** (see inside cover pages)

Vitrotek 3G: 97 silver - 96 white - 95 champagne - 92 old white - 90 chocolate - 86 black

Metaltek: 79 aluminium - 77 chromium - 73 titanium - 70 ghisa

Granitek: 68 bianco titano - 62 bianco antico - 59 antracite - 55 grigio - 54 nero - 53 terra - 52 bianco - 51 avena
43 tortora (new) - 41 cacao - 40 full black (new)

Quadra 110 undermount

one-bowl sink

Dimension: 580 x 440 mm
Built-in hole: 540 x 400 mm

MATERIAL	CODE
Vitrotek 3G	LVQ110__BSO
Metaltek	LMQ110__BSO
Granitek	LGQ110__BSO



To complete your order add the colour number chosen instead of dashes.

Accessories see page 119:

06 09 17 61 67 142 146

Packaging:

carton and polystyrene, m³ 0,11 approx.

Kit of the sink:

space-saving siphon,
wastes and undermounted kit.

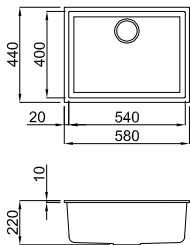

Quadra 105 undermount

one-bowl sink

Dimension: 540 x 440 mm
Built-in hole: 500 x 400 mm

MATERIAL	CODE
Vitrotek 3G	LVQ105__BSO
Metaltek	LMQ105__BSO
Granitek	LGQ105__BSO



To complete your order add the colour number chosen instead of dashes.

Accessories see page 119:

06 09 17 61 67 142 146

Packaging:

carton and polystyrene, m³ 0,11 approx.

Kit of the sink:

space-saving siphon,
wastes and undermounted kit.

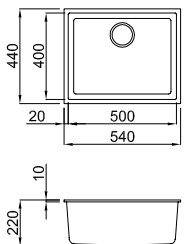

Available colours: QUADRA undermount 110/105 (see inside cover pages)

Vitrotek 3G: 97 silver - 96 white - 95 champagne - 92 old white - 90 chocolate - 86 black

Metaltek: 79 aluminium - 77 chromium - 73 titanium - 70 ghisa

Granitek: 68 bianco titano - 62 bianco antico - 59 antracite - 55 grigio - 54 nero - 53 terra - 52 bianco - 51 avena
43 tortora (new) - 41 cacao - 40 full black (new)



Quadra 100 undermount

one-bowl sink

Dimension: **380 x 440 mm**
Built-in hole: **340 x 400 mm**



Undermount

MATERIAL	CODE
Vitrotek 3G	LVQ100__BSO
Metaltek	LMQ100__BSO
Granitek	LGQ100__BSO



To complete your order add the colour number chosen instead of dashes.

Accessories see page 119:

06 09 17 61 66 142 146

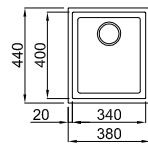

Packaging:

carton and polystyrene, m³ 0,07 approx.

Kit of the sink:

space-saving siphon, wastes and undermounted kit.

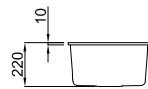

116
117



Quadra 50 undermount

one-bowl sink

Dimension: **200 x 440 mm**
Built-in hole: **160 x 400 mm**



Undermount

MATERIAL	CODE
Vitrotek 3G	LVQ050__BSO
Metaltek	LMQ050__BSO
Granitek	LGQ050__BSO



To complete your order add the colour number chosen instead of dashes.

Accessories see page 119:

09 142 146

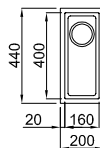

Packaging:

carton and polystyrene, m³ 0,04 approx.

Kit of the sink:

space-saving siphon, wastes and undermounted kit.

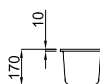

Available colours: **QUADRA undermount 100/50** (see inside cover pages)

Vitrotek 3G: 97 silver - 96 white - 95 champagne - 92 old white - 90 chocolate - 86 black

Metaltek: 79 aluminium - 77 chromium - 73 titanium - 70 ghisa

Granitek: 68 bianco titano - 62 bianco antico - 59 antracite - 55 grigio - 54 nero - 53 terra - 52 bianco - 51 avena
43 tortora (new) - 41 cacao - 40 full black (new)

Quadra 200 undermount

two-bowl sink

Dimension: **380 x 440 mm**
+ **380 x 440 mm**

MATERIAL	CODE
Vitrotek 3G	LVQ200__BSO
Metaltek	LMQ200__BSO
Granitek	LGQ200__BSO



To complete your order add the colour number chosen instead of dashes.

Accessories see page 119:

06 09 17 61 66 143 146

Packaging:

carton and polystyrene, m³ 0,13 approx.

Kit of the sink:

space-saving siphon, wastes and undermounted kit.

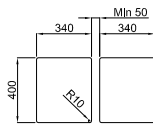
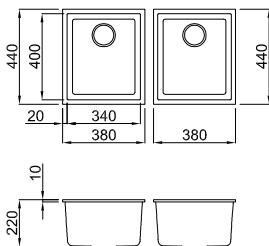

Built-in hole:



66

AGB01305
Bottom grid M



Min. distance 50 mm

Quadra 210 undermount

two-bowl sink

Dimension: **580 x 440 mm**
+ **380 x 440 mm**

MATERIAL	CODE
Vitrotek 3G	LVQ210__BSO
Metaltek	LMQ210__BSO
Granitek	LGQ210__BSO



To complete your order add the colour number chosen instead of dashes.

Accessories see page 119:

06 09 17 61 66 67 143 146

Packaging:

carton and polystyrene, m³ 0,13 approx.

Kit of the sink:

space-saving siphon, wastes and undermounted kit.

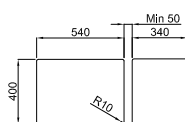
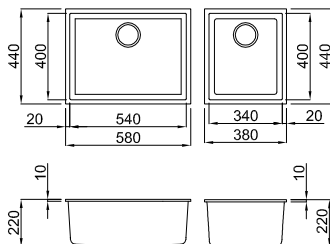

Built-in hole:



66

AGB01305
Bottom grid M

67

AGB01304
Bottom grid M



Min. distance 50 mm

Available colours: **QUADRA undermount 200/210** (see inside cover pages)

Vitrotek 3G: 97 silver - 96 white - 95 champagne - 92 old white - 90 chocolate - 86 black

Metaltek: 79 aluminium - 77 chromium - 73 titanium - 70 ghisa

Granitek: 68 bianco titano - 62 bianco antico - 59 antracite - 55 grigio - 54 nero - 53 terra - 52 bianco - 51 avena

43 tortora (new) - 41 cacao - 40 full black (new)



118
119

SUGGESTED MIXERS

79 aluminium



BRIDGE

code MMKBRI79



86 black



DOVE

code MVKDOV86



73 titanium



VOLTA

code MMKVTA73

Suggested accessories **Quadra** collection

A richer and studied accessories outfit features our sink proposals.

For each of our model a accessories series is provided for enriching the aesthetics and functionality of our sinks.

We studied integrated systems of accessories, which exploit each of your movement.



ATL01000
Sliding wooden chopping board

04



AVI03001
Colander

05



ATL01001
Wooden chopping board with insert HPE (178 x 178 mm)

06



ADI01300
Dish drainer

09



ACI01301
Basket

17



ATV01001
Glass sliding chopping board

24



ADI02300
Round soap dispenser

25



ADI02301
Compact and squared soap dispenser (H. 40 mm)

50

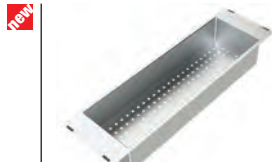

AVI03305
Colander std L

61

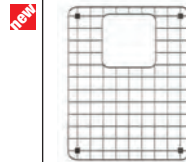

AGB01305
Bottom grid S

66

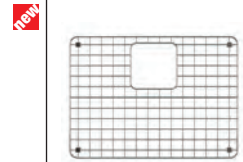

AGB01304
Bottom grid M

67

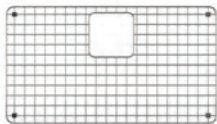

AGB01303
Bottom grid L

68



ASP13000
Pop-up waste 1 way - 3,5" round strainer plug and square control knob

141



ANP13000
Waste accessory kit 1 way - 3,5" manual square strainer plug

142



ASP13001
Pop-up waste 1 way - 3,5" square strainer plug and control knob

143



ACPM1000
Manual waste cover

146



ACPA1000
Pop-up waste cover

147

120
121



TEKNO

COLLECTION

Tekno 500
two-bowl sink with draining area

Tekno 490
two-bowl sink

Tekno 480
one-bowl sink with draining area

Tekno 475
one and half bowl sink with draining area

Tekno 450
two-bowl sink

Tekno 400
one-bowl sink with draining area

Tekno CORNER
two-bowl sink with draining area

Shapes which customize your kitchen.

A sinks collection featured by modern and winning design and by marked lines which confer to it a perfect shape. Each model can be equipped with many accessories and the many colours.



122
123



Inset:

The rim of the sink after installation appears on the worktop.



Pop-up waste:

1 way included.



New accessory: manual and pop-up waste cover.

- SPACE-SAVING SIPHON
- OVERFLOW ELLECI
- PRE-MOUNTED HOOKS



Elleci sinks have a **TOTAL ANTIBACTERIAL PROTECTION**, which has an adequate antibacterial coverage of the mass. In this way the bacterial organisms are repelled. Reliability and practicality become a certainty every day in the kitchen.



GK-MK-VK Sinks



Inset

Tekno 500

two-bowl sink with draining area

Dimension: **1160 x 500 mm**

Built-in hole: **1140 x 480 mm**

MATERIAL	CODE
Vitrotek 3G	LVT500
Metatek	LMT500
Granitek	LGT500



To complete your order add the colour number chosen at the end of the code.

Accessories see page 129:

01 02 03 04 05 07 09 42 64 140 146 147

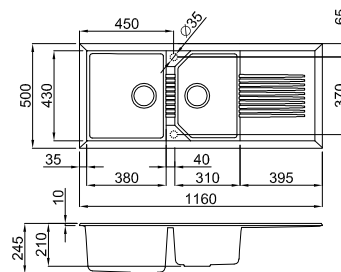

Packaging:

carton and polystyrene, m³ 0,20 approx.

Kit of the sink:

round pop up waste 1 way,
pre-mounted hooks and space-saving siphon.

124
125



Inset

Tekno 490

two-bowl sink

Dimension: **1000 x 500 mm**

Built-in hole: **980 x 480 mm**

MATERIAL	CODE
Vitrotek 3G	LVT490
Metatek	LMT490
Granitek	LGT490



To complete your order add the colour number chosen at the end of the code.

Accessories see page 129:

01 02 03 04 05 07 09 65 140 146 147

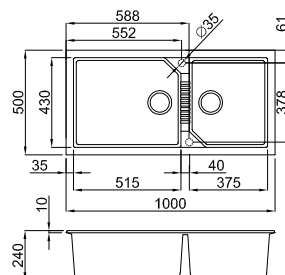

Packaging:

carton and polystyrene, m³ 0,17 approx.

Kit of the sink:

round pop up waste 1 way,
pre-mounted hooks and space-saving siphon.

Available colours: **TEKNO 500/490** (see inside cover pages)

Vitrotek 3G: 97 silver - 96 white - 95 champagne - *94 ice u.s.l. - 92 old white - 90 chocolate - 86 black

Metatek: 79 aluminium - 77 chromium - 73 titanium - 70 ghisa

Granitek: 68 bianco titano - 62 bianco antico - 59 antracite - 55 grigio - 54 nero - 53 terra - 52 bianco - 51 avena

* (u.s.l.) until stock lasts

Tekno 480

one-bowl sink with draining area

Dimension: **1000 x 500 mm**
Built-in hole: **980 x 480 mm**

MATERIAL	CODE
Vitrotek 3G	LVT480
Metaltek	LMT480
Granitek	LGT480



To complete your order add the colour number chosen at the end of the code.

Accessories see page 129:

01 02 03 04 05 07 09 42 43 140 146 147

Packaging:

carton and polystyrene, m³ 0,17 approx.

Kit of the sink:

round pop up waste 1 way,
pre-mounted hooks and space-saving siphon.

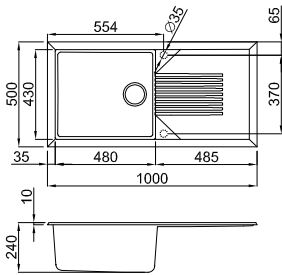

Tekno 475

one and half bowl sink with draining area

Dimension: **1000 x 500 mm**
Built-in hole: **980 x 480 mm**

MATERIAL	CODE
Vitrotek 3G	LVT475
Metaltek	LMT475
Granitek	LGT475



To complete your order add the colour number chosen at the end of the code.

Accessories see page 129:

01 02 03 04 07 09 42 62 64 140 146 147

Packaging:

carton and polystyrene, m³ 0,17 approx.

Kit of the sink:

round pop up waste 1 way,
pre-mounted hooks and space-saving siphon.

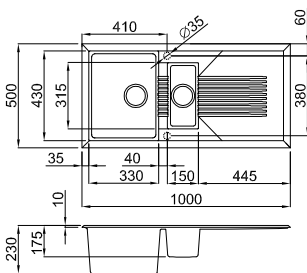

new



AVI03306
Colander 475
std S

62

Available colours: **TEKNO 480/475** (see inside cover pages)

Vitrotek 3G: 97 silver - 96 white - 95 champagne - *94 ice u.s.l. - 92 old white - *91 jada u.s.l. - 90 chocolate - 86 black

Metaltek: 79 aluminium - 77 chromium - 73 titanium - 70 ghisa

Granitek: 68 bianco titano - 62 bianco antico - 59 antracite - 55 grigio - 54 nero - 53 terra - 52 bianco - 51 avena

* (u.s.l.) until stock lasts



Tekno 450

two-bowl sink

Dimension: **860 x 500 mm**
Built-in hole: **840 x 480 mm**



MATERIAL	CODE
Vitrotek 3G	LVT450
Metaltek	LMT450
Granitek	LGT450



To complete your order add the colour number chosen at the end of the code.

Accessories see page 129:

01 02 03 04 05 07 09 65 140 146 147

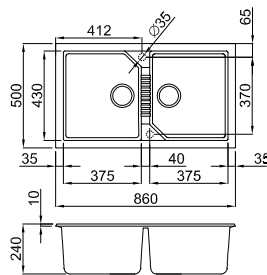

Packaging:

carton and polystyrene, m³ 0,15 approx.

Kit of the sink:

round pop up waste 1 way,
pre-mounted hooks and space-saving siphon.

126
127



Tekno 400

one-bowl sink with draining area

Dimension: **860 x 500 mm**
Built-in hole: **840 x 480 mm**



MATERIAL	CODE
Vitrotek 3G	LVT400
Metaltek	LMT400
Granitek	LGT400



To complete your order add the colour number chosen at the end of the code.

Accessories see page 129:

01 02 03 04 05 07 09 42 65 140 146 147

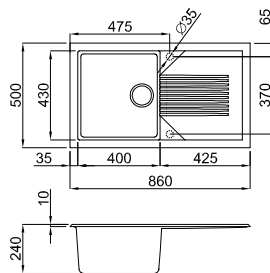

Packaging:

carton and polystyrene, m³ 0,15 approx.

Kit of the sink:

round pop up waste 1 way,
pre-mounted hooks and space-saving siphon.

Available colours: **TEKNO 450/400** (see inside cover pages)

Vitrotek 3G: 97 silver - 96 white - 95 champagne - *94 ice u.s.l. - 92 old white - 90 chocolate - 86 black

Metaltek: 79 aluminium - 77 chromium - 73 titanium - 70 ghisa

Granitek: 68 bianco titano - 62 bianco antico - 59 antracite - 55 grigio - 54 nero - 53 terra - 52 bianco - 51 avena

* (u.s.l.) until stock lasts

Tekno CORNER

two-bowl sink with draining area

Dimension: 830 x 830 mm

MATERIAL	CODE
Vitrotek 3G	LVTCOR
Metaltek	LMTCOR
Granitek	LGTCOR

To complete your order add the colour number chosen at the end of the code.

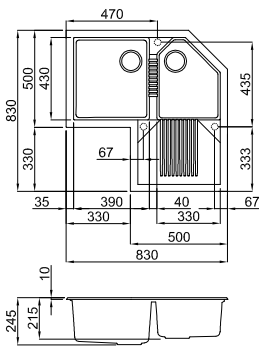

Accessories see page 129:

01 02 03 04 05 07 09 42 140 146 147

Packaging:

carton and polystyrene, m³ 0,23 approx.

Kit of the sink:

round pop up waste 1 way,
pre-mounted hooks and space-saving siphon.

Built-in hole:

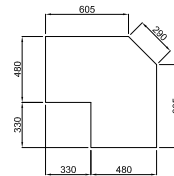

Available colours: **TEKNO CORNER** (see inside cover pages)

Vitrotek 3G: 97 silver - 96 white - 95 champagne - *94 ice u.s.l. - 92 old white - 90 chocolate - 86 black

Metaltek: 79 aluminium - 77 chromium - 73 titanium - 70 ghisa

Granitek: 68 bianco titano - 62 bianco antico - 59 antracite - 55 grigio - 54 nero - 53 terra - 52 bianco - 51 avena

* (u.s.l.) until stock lasts



128
129

SUGGESTED MIXERS



Chrome

BLADE
code MIKBLACR



96 white

SUNNY
code MVKSUN96



79 aluminium

STREAM PLUS
code MMKSTP79

Suggested accessories **Tekno** collection

A richer and studied accessories outfit features our sink proposals.

For each of our model a accessories series is provided for enriching the aesthetics and functionality of our sinks.

We studied integrated systems of accessories, which exploit each of your movement.



ATP01300
Polyethylene chopping board

01



ACI01300
Basket

02



AVP02001
Polycarbonate bowl

03



ATL01000
Tagliere in legno scorrevole

04



AVI03001
Colander

05



ATV01000
Sliding glass chopping board

07



ADI01300
Dish drainer

09

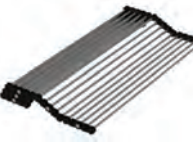

ARI01300
Rollmat

42

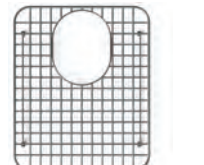

AGB01300
Bottom grid

43



AVI03306
Colander 475 std S

62

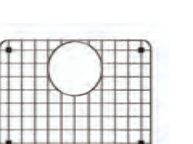

AGB01301
Bottom grid std S

64

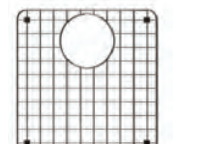

AGB01302
Bottom grid std M

65



ASP23000
Pop-up waste 2 ways - 3,5" round strainer plug and square control knob

140



ACPM1000
Manual waste cover

146



ACPA1000
Pop-up waste cover

147

130
131



EGO

COLLECTION

Ego 500
two-bowl sink with draining area

Ego 480
one-bowl sink with draining area

Ego 475
one and half bowl sink with draining area

Ego 450
two-bowl sink

Ego 400
one-bowl sink with draining area

Ego ESA
two-bowl sink with draining area

Ego CORNER
two-bowl sink with draining area

Ego ROUND
one-bowl sink

A fascinating design.

A sinks collection designed for meeting delicate tastes. Very light and curves lines which confer to this model a fascinating design. Each model can be equipped with many accessories and the many colours.

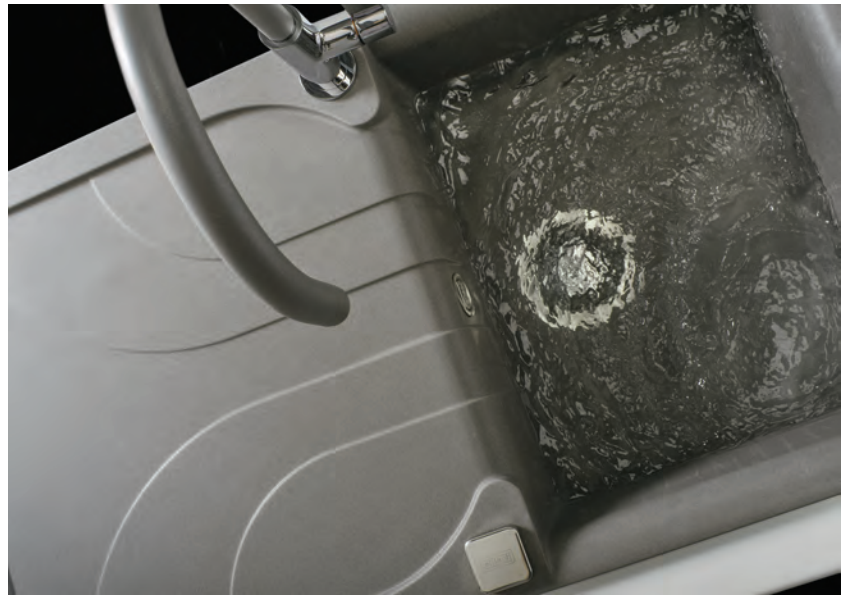

132
133



Inset:

The rim of the sink after installation appears on the worktop.



New accessory: waste cover.

- SPACE-SAVING SIPHON
- OVERFLOW ELLECI
- PRE-MOUNTED HOOKS



Elleci sinks have a **TOTAL ANTIBACTERIAL PROTECTION**, which has an adequate antibacterial coverage of the mass. In this way the bacterial organisms are repelled. Reliability and practicality become a certainty every day in the kitchen.





Inset

Ego 500

two-bowl sink with draining area
 Dimension: **1160 x 500 mm**
 Built-in hole: **1140 x 485 mm**

MATERIAL	CODE
Vitrotek 3G	LVE500
Metaltek	LME500
Granitek	LGE500



To complete your order add the colour number chosen at the end of the code.

Accessories see page 139:

03 04 05 09 17 24 25 42 64 140 146 147

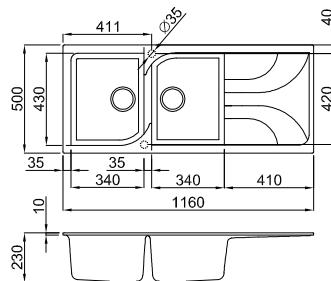

Packaging:

carton and polystyrene, m³ 0,20 approx.

Kit of the sink:

space-saving siphon, wastes and pre-mounted hooks.

134
135



Inset

Ego 480

one-bowl sink with draining area
 Dimension: **1000 x 500 mm**
 Built-in hole: **980 x 485 mm**

MATERIAL	CODE
Vitrotek 3G	LVE480
Metaltek	LME480
Granitek	LGE480



To complete your order add the colour number chosen at the end of the code.

Accessories see page 139:

03 04 05 09 17 24 25 42 43 141 146 147

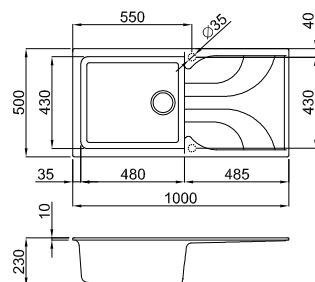

Packaging:

carton and polystyrene, m³ 0,17 approx.

Kit of the sink:

space-saving siphon, wastes and pre-mounted hooks.

Available colours: EGO 500/480 (see inside cover pages)

Vitrotek 3G: 96 white - 95 champagne - 90 chocolate - 86 black

Metaltek: 79 aluminium - 77 chromium - 73 titanium - 72 rame - *71 alluminio u.s.i. - 70 ghisa

Granitek: 68 bianco titano - 62 bianco antico - 59 antracite - 55 grigio - 54 nero - 53 terra - 52 bianco - 51 avena - 43 tortora (new)

* (u.s.i.) until stock lasts

Ego 475

one and half bowl sink with draining area

Dimension: **1000 x 500 mm**

Built-in hole: **980 x 485 mm**

MATERIAL	CODE
Vitrotek 3G	LVE475
Metaltek	LME475
Granitek	LGE475



To complete your order add the colour number chosen at the end of the code.

Accessories see page 139:

03 04 05 09 17 24 25 42 64 140 146 147

Packaging:

carton and polystyrene, m³ 0,17 approx.

Kit of the sink:

space-saving siphon,
wastes and pre-mounted hooks.

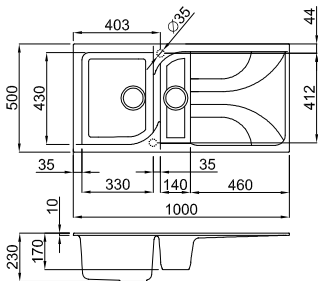

Ego 450

two-bowl sink

Dimension: **860 x 500 mm**

Built-in hole: **840 x 485 mm**

MATERIAL	CODE
Vitrotek 3G	LVE450
Metaltek	LME450
Granitek	LGE450



To complete your order add the colour number chosen at the end of the code.

Accessories see page 139:

03 04 05 09 17 24 25 65 140 146 147

Packaging:

carton and polystyrene, m³ 0,15 approx.

Kit of the sink:

space-saving siphon,
wastes and pre-mounted hooks.

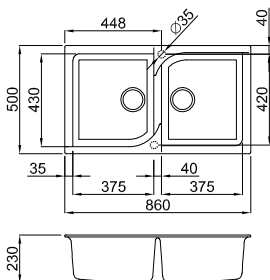

Available colours: **EGO 475/450** (see inside cover pages)

Vitrotek 3G: 96 white - 95 champagne - 90 chocolate - 86 black

Metaltek: 79 aluminium - 77 chromium - 73 titanium - 72 rame - *71 alluminio u.s.i. - 70 ghisa

Granitek: 68 bianco titano - 62 bianco antico - 59 antracite - 55 grigio - 54 nero - 53 terra - 52 bianco - 51 avena - 43 tortora (new)

* (u.s.i.) until stock lasts



Inset

Ego 400

one-bowl sink with draining area
Dimension: **860 x 500 mm**
Built-in hole: **840 x 485 mm**

MATERIAL	CODE
Vitrotek 3G	LVE400
Metaltek	LME400
Granitek	LGE400



To complete your order add the colour number chosen at the end of the code.

Accessories see page 139:

03 04 05 09 17 24 25 42 64 141 146 147

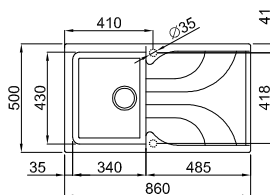

Packaging:

carton and polystyrene, m³ 0,15 approx.

Kit of the sink:

space-saving siphon,
wastes and pre-mounted hooks.

136
137



Inset

Ego ESA

two-bowl sink with draining area
Dimension: **1000 x 500 mm**

MATERIAL	CODE
Vitrotek 3G	LVEESA
Metaltek	LMEESA
Granitek	LGEESA



To complete your order add the colour number chosen at the end of the code.

Accessories see page 139:

03 04 05 09 17 24 25 140 146 147

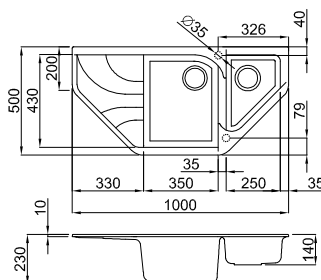

Packaging:

carton and polystyrene, m³ 0,20 approx.

Kit of the sink:

space-saving siphon,
wastes and pre-mounted hooks.

Built-in hole:

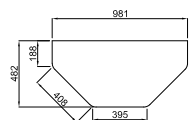

Available colours: EGO 400/ESA (see inside cover pages)

Vitrotek 3G: 96 white - 95 champagne - 90 chocolate - 86 black

Metaltek: 79 aluminium - 77 chromium - 73 titanium - 72 rame - *71 alluminio u.s.i. - 70 ghisa

Granitek: 68 bianco titano - 62 bianco antico - 59 antracite - 55 grigio - 54 nero - 53 terra - 52 bianco - 51 avena - 43 tortora (new)

* (u.s.i.) until stock lasts

Ego CORNER

two-bowl sink with draining area
Dimension: 1000 x 500 mm

MATERIAL	CODE
Vitrotek 3G	LVECOR
Metaltek	LMECOR
Granitek	LGECOR



To complete your order add the colour number chosen at the end of the code.

Accessories see page 139:

03 04 05 09 17 24 25 140 146 147

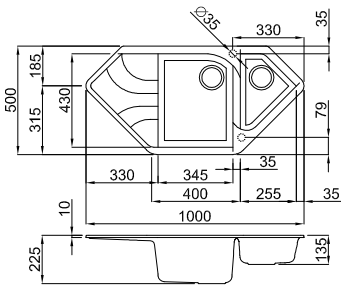

Packaging:

carton and polystyrene, m³ 0,20 approx.

Kit of the sink:

space-saving siphon, wastes and pre-mounted hooks.

Built-in hole:

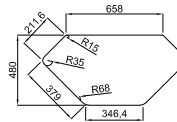

Ego ROUND

one-bowl sink

Dimension: Ø 485 mm
Built-in hole: Ø 465 mm

MATERIAL	CODE
Vitrotek 3G	LVEROU
Metaltek	LMEROU
Granitek	LGEROU

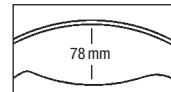

available 78 mm for mixer hole



To complete your order add the colour number chosen at the end of the code.

Accessories see page 139:

08 09 10 141 146 147

08

10



ACI02300
Basket round



ATL02300
Wooden chopping board

Packaging:

carton and polystyrene, m³ 0,06 approx.

Kit of the sink:

space-saving siphon, wastes and pre-mounted hooks.

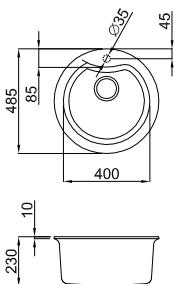

Available colours: EGO CORNER/ROUND (see inside cover pages)

Vitrotek 3G: 96 white - 95 champagne - *91 jada u.s.l. - 90 chocolate - 86 black

Metaltek: 79 aluminium - 77 chromium - 73 titanium - 72 rame - *71 alluminio u.s.l. - 70 ghisa

Granitek: 68 bianco titano - 62 bianco antico - 59 antracite - 55 grigio - 54 nero - 53 terra - 52 bianco - 51 avena - 43 tortora (new)

* (u.s.l.) until stock lasts



138
139

SUGGESTED MIXERS

Chrome



CUPIDO
code MIKCUPCR

73 titanium



VOLTA
code MMKVTA73

86 black



RENO PLUS
code MVKREP86



Suggested accessories **Ego** collection

A richer and studied accessories outfit features our sink proposals.

For each of our model a accessories series is provided for enriching the aesthetics and functionality of our sinks.

We studied integrated systems of accessories, which exploit each of your movement.



AVP02001
Polycarbonate bowl

03



ATL01000
Sliding wooden chopping board

04



AVI03001
Colander

05



ADI01300
Dish drainer

09



ACI01301
Basket

17



ATV01001
Glass sliding chopping board

24



ADI02300
Round soap dispenser

25

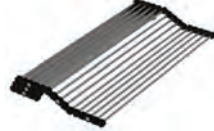

ARI01300
Rollmat

42

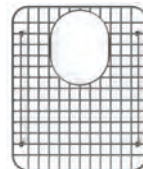

AGB01300
Bottom grid

43

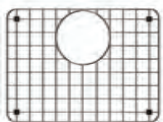

AGB01301
Bottom grid std S

64

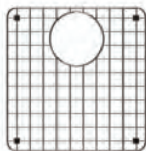

AGB01302
Bottom grid std M

65



ASP23000
Pop-up waste 2 ways - 3,5" round strainer plug and square control knob

140



ASP13000
Pop-up waste 1 way - 3,5" round strainer plug and square control knob

141



ACPM1000
Manual waste cover

146



ACPA1000
Pop-up waste cover

147

140
141



EASY

COLLECTION

Easy 425
one and half bowl sink with draining area

Easy 325
one and half bowl sink with draining area

Easy 300
one-bowl sink with draining area

Easy 290
one-bowl sink with draining area

Easy 150
two-bowl sink

Easy 135
one-bowl sink with draining area

Easy CORNER
one and half bowl sink with draining area

Easy ROUND 600
one-bowl sink with draining area

Prisma-Clean prismatic edges sinks.

An essential project inspired by an unique, timeless concept.

Unique products featured by a marked innovative character which blends the extreme functionality with the ability to “model itself” to the user requirements up to completely disappear.



Prisma-Clean:
prismatic
edge sinks.

*II PRISMA-CLEAN:
prismatic radius born
by softness of a curve.
Prismatic section corners tend
to blend those particular points
difficult to reach and to clean
together with a soft shape,
even if marking the sink by
straight and sharp lines.
The result is a look by an
extraordinary visual impact
and marked innovative side.*

PRISMA-CLEAN: prismatic edge sinks.

The PrismaClean system, which exploits the polyhedric nature of this particular geometry, replaces the classic internal radius, particularly reduced on modern lines products, with prismatic lines which soften the inner area of the bowl and make the cleaning easier. An extremely modern character with an exclusive visual impact.

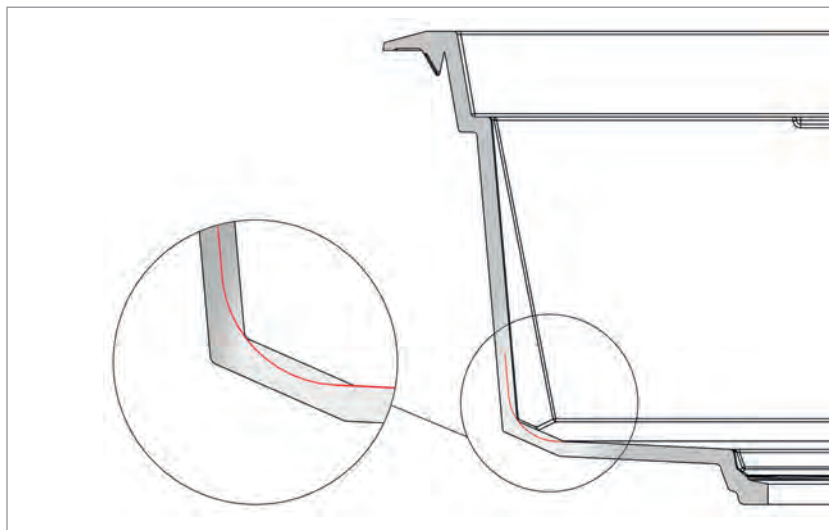

Inset:
The rim of the sink after installation
appears on the worktop.



New accessory: waste cover.

- SPACE-SAVING SIPHON
- OVERFLOW ELLECI
- PRE-MOUNTED HOOKS



Elleci sinks have a **TOTAL ANTIBACTERIAL PROTECTION**, which has an adequate antibacterial coverage of the mass. In this way the bacterial organisms are repelled. Reliability and practicality become a certainty every day in the kitchen.





Easy 425

one and half bowl sink with draining area

Dimension: **860 x 435** mm

Built-in hole: **840 x 415** mm

MATERIAL	CODE
Metaltek	LMY425
Granitek	LGY425



To complete your order add the colour number chosen at the end of the code.

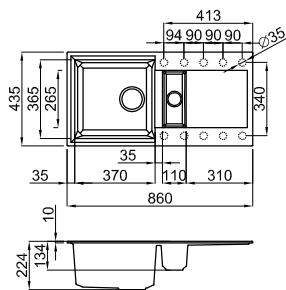

Accessories see page 149:

25 42 50 58 60 65 141 146 147

Packaging:

carton and polystyrene, m³ 0,14 approx.

Kit of the sink:

space-saving siphon, wastes and pre-mounted hooks.

144
145



Easy 325

one and half bowl sink with draining area

Dimension: **780 x 500** mm

Built-in hole: **760 x 480** mm

MATERIAL	CODE
Metaltek	LMY325
Granitek	LGY325



To complete your order add the colour number chosen at the end of the code.

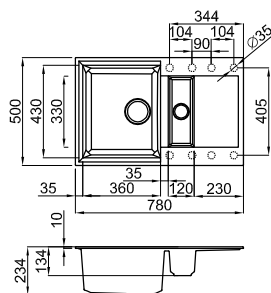

Accessories see page 149:

04 17 25 50 57 60 64 65 141 146 147

Packaging:

carton and polystyrene, m³ 0,13 approx.

Kit of the sink:

space-saving siphon, wastes and pre-mounted hooks.

Available colours: **EASY 425/325** (see inside cover pages)

Metaltek: 79 aluminium - 77 chromium - 73 titanium - 70 ghisa

Granitek: 68 bianco titano - 62 bianco antico - 61 pietra antica - 59 antracite - 55 grigio - 53 terra - 52 bianco - 51 avena 43 tortora (new) - 41 cacao - 40 full black

Easy 300

one-bowl sink with draining area

Dimension: 790 x 500 mm

Built-in hole: 770 x 480 mm

NEW

MATERIAL	CODE
Metaltek	LMY300
Granitek	LGY300



To complete your order add the colour number chosen at the end of the code.

Accessories see page 149:

04 05 17 25 42 50 59 65 141 143 146 147

Packaging:

carton and polystyrene, m³ 0,13 approx.

Kit of the sink:

space-saving siphon,
wastes and pre-mounted hooks.

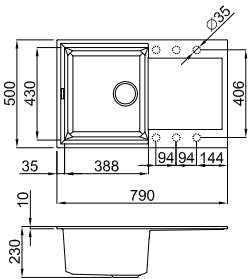

Easy 290

one-bowl sink with draining area

Dimension: 780 x 435 mm

Built-in hole: 760 x 415 mm

NEW

MATERIAL	CODE
Metaltek	LMY290
Granitek	LGY290



To complete your order add the colour number chosen at the end of the code.

Accessories see page 149:

05 25 42 50 58 65 141 143 146 147

Packaging:

carton and polystyrene, m³ 0,13 approx.

Kit of the sink:

space-saving siphon,
wastes and pre-mounted hooks.

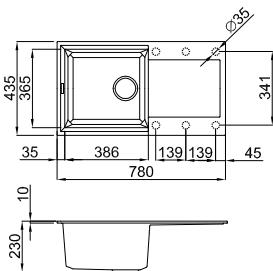

Available colours: EASY 300/290 (see inside cover pages)

Metaltek: 79 aluminium - 77 chromium - 73 titanium - 70 ghisa

Granitek: 68 bianco titano - 62 bianco antico - 61 pietra antica - 59 antracite - 55 grigio - 53 terra - 52 bianco - 51 avena
43 tortora (new) - 41 cacao - 40 full black



Easy 150

two-bowl sink

Dimension: **600 x 500 mm**
Built-in hole: **580 x 480 mm**

new!

MATERIAL	CODE
Metaltek	LMY150
Granitek	LGY150



To complete your order add the colour number chosen at the end of the code.

Accessories see page 149:

04 17 25 50 60 64 141 146 147

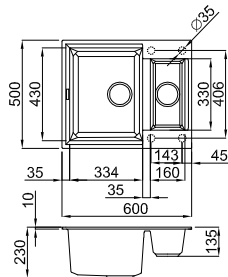

Packaging:

carton and polystyrene, m³ 0,10 approx.

Kit of the sink:

space-saving siphon,
wastes and pre-mounted hooks.

146
147

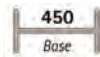

Easy 135

one-bowl sink with draining area

Dimension: **680 x 500 mm**
Built-in hole: **660 x 480 mm**

new!

MATERIAL	CODE
Metaltek	LMY135
Granitek	LGY135



To complete your order add the colour number chosen at the end of the code.

Accessories see page 149:

04 05 17 25 42 50 59 64 141 143 146 147

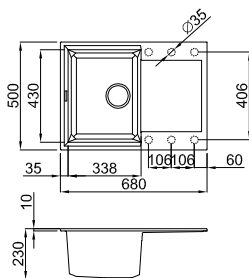

Packaging:

carton and polystyrene, m³ 0,11 approx.

Kit of the sink:

space-saving siphon,
wastes and pre-mounted hooks.

Available colours: **EASY 150/135** (see inside cover pages)

Metaltek: 79 aluminium - 77 chromium - 73 titanium - 70 ghisa

Granitek: 68 bianco titano - 62 bianco antico - 61 pietra antica - 59 antracite - 55 grigio - 53 terra - 52 bianco - 51 avena
43 tortora (**new**) - 41 cacao - 40 full black

Easy CORNER NEW

one and half bowl sink with draining area
Dimension: 1057 x 575 mm

MATERIAL	CODE
Metaltek	LMYCOR
Granitek	LGYCOR

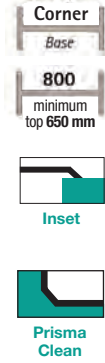
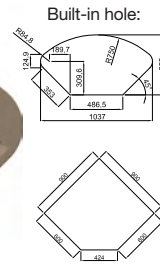

To complete your order add the colour number chosen at the end of the code.

Accessories see page 149:

05 17 25 50 63 146 147

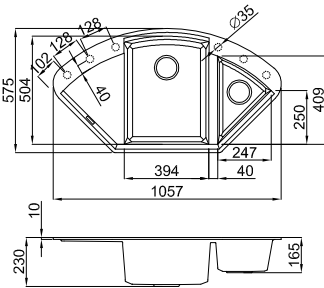

Packaging:
carton and polystyrene, m³ 0,10 approx.

Kit of the sink:
space-saving siphon, wastes and pre-mounted hooks.

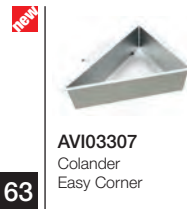

Available colours: **EASY CORNER** (see inside cover pages)
Metaltek: 79 aluminium - 77 chromium - 73 titanium - 70 ghisa
Granitek: 68 bianco titano - 62 bianco antico - 61 pietra antica - 59 antracite - 55 grigio - 53 terra - 52 bianco - 51 avena
 43 tortora (new) - 41 cacao - 40 full black



Easy ROUND 600

one-bowl sink with draining area
Dimension: **600 x 470 mm**

MATERIAL	CODE
Metaltek	LMYR60
Granitek	LGYR60

To complete your order add the colour number chosen at the end of the code.

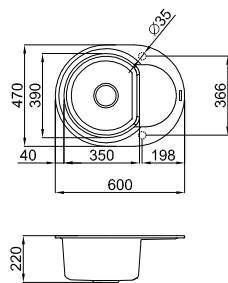
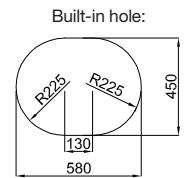

Accessories see page 149:

15 25 50 141 146 147

Packaging:
carton and polystyrene, m³ 0,10 approx.

Kit of the sink:
space-saving siphon,
wastes and pre-mounted hooks.



ACI02301
Basket
Round

15

Available colours: EASY ROUND 600 (see inside cover pages)

Metaltek: 79 aluminium - 77 chromium - 73 titanium - 70 ghisa

Granitek: 68 bianco titano - 62 bianco antico - 61 pietra antica - 59 antracite 55 grigio - 53 terra - 52 bianco - 51 avena - 43 tortora (new) - 41 cacao - 40 full black

148
149



SUGGESTED MIXERS

Chrome



JUST PLUS
code MIKJUPCR

86 black



JUST
code MVKJUS86

73 titanium



RENO PLUS
code MMKREP73

Suggested accessories **Easy** collection

A richer and studied accessories outfit features our sink proposals.

For each of our model a accessories series is provided for enriching the aesthetics and functionality of our sinks.

We studied integrated systems of accessories, which exploit each of your movement.



ATL01000
Sliding wooden chopping board

04

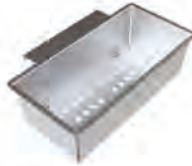

AVI03001
Colander

05



ACI01301
Basket

17



ADI02300
Round soap dispenser

25



ARI01300
Rollmat

42



ADI02301
Compact and squared soap dispenser (H. 40 mm)

50



AGD01300
Drainer Easy S

57



AGD01302
Drainer Easy M

58



AGD01301
Drainer Easy L

59

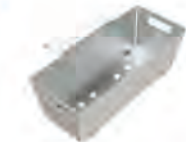

AVI03304
Colander Easy S

60



Dim.: 400 x 284 x 80 mm

AVI03307
Colander Easy Corner

63

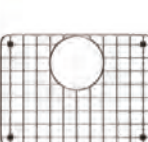

AGB01301
Bottom grid std S

64

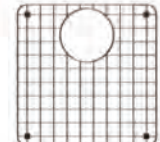

AGB01302
Bottom grid std M

65



ASP13000
Pop-up waste 1 way - 3,5" round strainer plug and square control knob

141



ASP13001
Pop-up waste 1 way - 3,5" square strainer plug and control knob

143



ACPM1000
Manual waste cover

146



ACPA1000
Pop-up waste cover

147

150
151



FOX

COLLECTION

Fox 580
one-bowl sink with draining area

Fox 450
two-bowl sink

Fox 430
two-bowl sink

Fox 360
one-bowl sink

Fox 340
two-bowl sink

Fox 330
two-bowl sink

Fox 250
one-bowl sink

Fox 200
one-bowl sink

Fox ROUND
one-bowl sink

Models designed for versatile spaces.

A very versatile sinks collection. It perfectly fits each available space on the kitchen top. Each model can be equipped with many accessories and the many colours.



152
153



Inset:

The rim of the sink after installation appears on the worktop.



New accessory: waste cover.

- SPACE-SAVING SIPHON
- OVERFLOW ELLECI
- PRE-MOUNTED HOOKS



Elleci sinks have a **TOTAL ANTIBACTERIAL PROTECTION**, which has an adequate antibacterial coverage of the mass. In this way the bacterial organisms are repelled. Reliability and practicality become a certainty every day in the kitchen.





Inset

Fox 580

one-bowl sink with draining area

Dimension: **1160 x 500 mm**

Built-in hole: **1140 x 480 mm**

new

MATERIAL	CODE
Metaltek	LMF580
Granitek	LGF580



To complete your order add the colour number chosen at the end of the code.

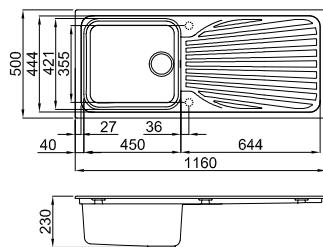

Accessories see page 159:

04 05 09 17 24 25 141 146 147 149

Packaging:

carton and polystyrene, m³ 0,20 approx.

Kit of the sink:

space-saving siphon, wastes and pre-mounted hooks.

Available colours: FOX 580 (see inside cover pages)

Metaltek: 79 aluminium - 73 titanium

Granitek: 68 bianco titano - 62 bianco antico - 51 avena - 40 full black

154
155



Inset

Fox 450

two-bowl sink

Dimension: **860 x 500 mm**

Built-in hole: **840 x 480 mm**

MATERIAL	CODE
Granitek	LGF450



To complete your order add the colour number chosen at the end of the code.

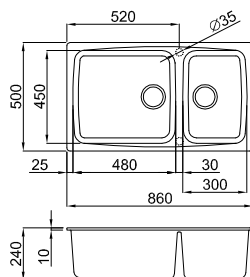

Accessories see page 159:

04 05 09 17 24 25 140 146 147 148

Packaging:

carton and polystyrene, m³ 0,15 approx.

Kit of the sink:

space-saving siphon, wastes and pre-mounted hooks.

Available colours: FOX 450 (see inside cover pages)

Granitek: *76 hamada u.s.l. - *74 avrelle u.s.l. - *69 vaniglia u.s.l.

68 bianco titano - 62 bianco antico - 59 antracite - 55 grigio - 54 nero - 53 terra - 52 bianco - 51 avena - 41 cacao - 40 full black

* (u.s.l.) until stock lasts

Fox 430

two-bowl sink

Dimension: 860 x 500 mm

Built-in hole: 840 x 490 mm

MATERIAL	CODE
Granitek	LGF430



To complete your order add the colour number chosen at the end of the code.

Accessories see page 159:

04 05 09 17 24 25 140 146 147 148

Packaging:

carton and polystyrene, m³ 0,15 approx.

Kit of the sink:

space-saving siphon, wastes and pre-mounted hooks.

Available colours: **FOX 430** (see inside cover pages)

Granitek: 62 bianco antico - 59 antracite - 52 bianco - 51 avena - 40 full black

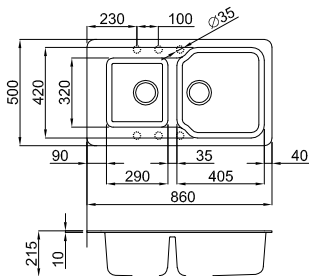

Fox 360

one-bowl sink

Dimension: 860 x 500 mm

Built-in hole: 840 x 480 mm

MATERIAL	CODE
Metaltek	LMF360
Granitek	LGF360



To complete your order add the colour number chosen at the end of the code.

Accessories see page 159:

04 09 11 12 13 14 25 141 146 147 149

Packaging:

carton and polystyrene, m³ 0,15 approx.

Kit of the sink:

space-saving siphon, wastes and pre-mounted hooks.

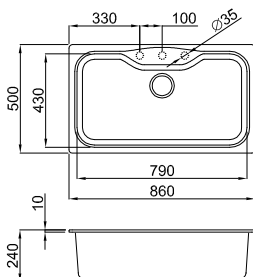

11

ACI03300
Basket
Fox 360

12

ATL03000
Wooden
chopping board
Fox 360

13

ATP01301
Polyethylene
chopping
board

14

AVP01301
Polycarbonate
bowl

Available colours: **FOX 360** (see inside cover pages)

Metaltek: 79 aluminium - 77 chromium - 73 titanium - 72 rame - 70 ghisa

Granitek: *76 hamada u.s.i. - *69 vaniglia u.s.i. - 68 bianco titano - 62 bianco antico - 61 pietra antica - 59 antracite
57 pietra vecchia - 55 grigio - 54 nero - 53 terra - 52 bianco - 51 avena - 41 cacao - 40 full black

* (u.s.i.) until stock lasts



Fox 340

two-bowl sink

Dimension: **800 x 530 mm**
Built-in hole: **780 x 510 mm**



Inset

MATERIAL	CODE
Granitek	LGF340__BTP



For the built-in hole observe the radius.



To complete your order add the colour number chosen instead of dashes.

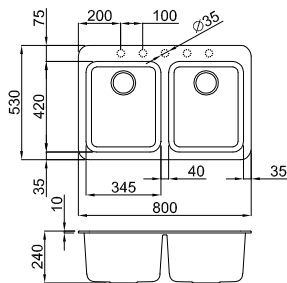

Accessories see page 159:

05 09 17 25 43 140 146 147 148

Packaging:
carton and polystyrene, m³ 0,13 approx.

Kit of the sink:
space-saving siphon, wastes and pre-mounted hooks.

43

AGB01300
Bottom grid



Available colours: FOX 340 (see inside cover pages)

Granitek: 62 bianco antico - 59 antracite - 52 bianco - 51 avena - 40 full black

156
157



Fox 330

two-bowl sink

Dimension: **700 x 530 mm**
Built-in hole: **680 x 510 mm**



Inset

MATERIAL	CODE
Granitek	LGF330__BTP



For the built-in hole observe the radius.



To complete your order add the colour number chosen instead of dashes.

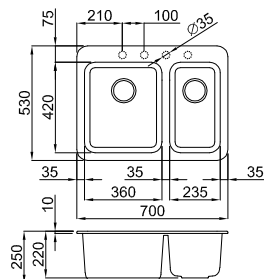

Accessories see page 159:

05 09 17 25 43 140 146 147 148

Packaging:
carton and polystyrene, m³ 0,11 approx.

Kit of the sink:
space-saving siphon, wastes and pre-mounted hooks.

43

AGB01300
Bottom grid



Available colours: FOX 330 (see inside cover pages)

Granitek: 62 bianco antico - 59 antracite - 52 bianco - 51 avena - 40 full black

Fox 250

one-bowl sink

Dimension: 600 x 520 mm

Built-in hole: 580 x 500 mm

MATERIAL	CODE
Granitek	LGF250__BTP



For the built-in hole observe the radius.



To complete your order add the colour number chosen instead of dashes.

Accessories see page 159:

04 09 17 60 141 146 147 149

Packaging:

carton and polystyrene, m³ 0,10 approx.

Kit of the sink:

space-saving siphon, wastes and pre-mounted hooks.

Available colours: FOX 250 (see inside cover pages)

Granitek: 68 bianco titano - 62 bianco antico - 52 bianco - 51 avena

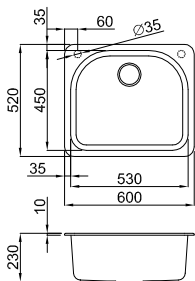

Fox 200

one-bowl sink

Dimension: 580 x 500 mm

Built-in hole: 560 x 480 mm

MATERIAL	CODE
Metaltek	LMF200
Granitek	LGF200



For the built-in hole observe the radius.



To complete your order add the colour number chosen at the end of the code.

Accessories see page 159:

04 09 17 60 141 146 147 149

Packaging:

carton and polystyrene, m³ 0,10 approx.

Kit of the sink:

space-saving siphon, wastes and pre-mounted hooks.

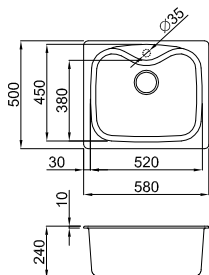

Available colours: FOX 200 (see inside cover pages)

Metaltek: 79 aluminium - 77 chromium - 73 titanium - 72 rame - *71 alluminio u.s.l. - 70 ghisa

Granitek: *76 hamada u.s.l. - *74 avrelle u.s.l. - *69 vaniglia u.s.l. - 68 bianco titano - 62 bianco antico - 61 pietra antica - 59 antracite - 57 pietra vecchia - 55 grigio - 54 nero - 53 terra - 52 bianco - 51 avena - 41 cacao - 40 full black

* (u.s.l.) until stock lasts



Fox ROUND

one-bowl sink
 Dimension: Ø 450 mm
 Built-in hole: Ø 420 mm



MATERIAL	CODE
Granitek	LGFROU
Sintek	LSFROU
Sintek 12 t.d.f.	LSFROU12



ACI02301
Basket
Round

15



ATL02301
Wooden
chopping board
Round

16

To complete your order add the colour number chosen at the end of the code.

Accessories see page 159:

09 15 16 141 146 147 149

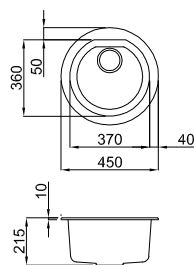

Packaging:
carton and polystyrene, m³ 0,06 approx.

Installation tap: on the worktop

Kit of the sink:
space-saving siphon, wastes and pre-mounted hooks.

Available colours: FOX ROUND (see inside cover pages)
Granitek: *74 avrelle u.s.l. - *69 vaniglia u.s.l. - 68 bianco titano
 62 bianco antico - 61 pietra antica - 59 antracite - 57 pietra vecchia
 55 grigio - 54 nero - 53 terra - 52 bianco - 51 avena - 41 cacao - 40 full black
Sintek: 13 nero - 12 terra di francia - 11 bianco

* (u.s.l.) until stock lasts

158
159



SUGGESTED MIXERS

59 antracite



URANO
code MGKURA59

Chrome



SENNA
code MIKSENCR

51 avena



PO
code MGKPO51

Suggested accessories **FOX** collection

A richer and studied accessories outfit features our sink proposals.

For each of our model a accessories series is provided for enriching the aesthetics and functionality of our sinks.

We studied integrated systems of accessories, which exploit each of your movement.



ATL01000
Sliding wooden chopping board

04



AVI03001
Colander

05

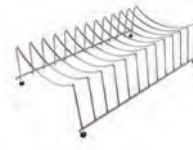

ADI01300
Dish drainer

09



ACI01301
Basket

17



ATV01001
Glass sliding chopping board

24



ADI02300
Round soap dispenser

25

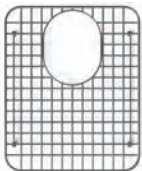

AGB01300
Bottom grid

43

new

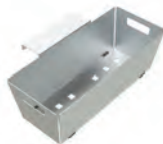

AVI03304
Colander Easy S

60



ASP23000
Pop-up waste 2 ways - 3,5" round strainer plug and square control knob

140



ASP13000
Pop-up waste 1 way - 3,5" round strainer plug and square control knob

141

new



ACPM1000
Manual waste cover

146

new



ACPA1000
Pop-up waste cover

147

new



APM2VCTPGO
Euro 105
Piletta 3,5" 2 vie ottonata

148

new



APM1VCTPGO
Euro 59
Piletta 3,5" 1 via ottonata

149

160
161



MASTER

COLLECTION

Master 550
two and half bowl sink

Master 500
two-bowl sink with draining area

Master 475
one and half bowl sink with draining area

Master 450
two-bowl sink

Master 400
one-bowl sink with draining area

Master 350
two-bowl sink

Master 300
one-bowl sink with draining area

Master CORNER
two-bowl sink with draining area

A highly warm design.

A country sinks collection, perfect for those who prefer the warmth and classic but with a strong personality. Each model can be equipped with many accessories and the many colours.



162
163



Inset:

The rim of the sink after installation appears on the worktop.



New accessory: waste cover.

- SPACE-SAVING SIPHON
- OVERFLOW ELLECI
- PRE-MOUNTED HOOKS



Elleci sinks have a **TOTAL ANTIBACTERIAL PROTECTION**, which has an adequate antibacterial coverage of the mass. In this way the bacterial organisms are repelled. Reliability and practicality become a certainty every day in the kitchen.





Master 550

two and half bowl sink
 Dimension: **1000 x 500 mm**
 Built-in hole: **980 x 480 mm**



Inset

MATERIAL	CODE
Granitek	LGM550



To complete your order add the colour number chosen at the end of the code.

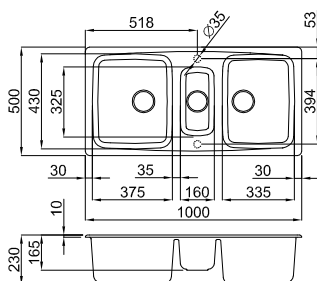

Accessories see page 169:

04 05 09 14 17 19 25 65 140 146 147

Packaging:
 carton and polystyrene, m³ 0,20 approx.

Kit of the sink:
 space-saving siphon,
 wastes and pre-mounted hooks.

14



AVP01301
 Polycarbonate
 bowl

Available colours: MASTER 550 (see inside cover pages)
Granitek: *76 hamada u.s.i. - *74 avrelle u.s.i. - *69 vaniglia u.s.i. - 62 bianco antico
 61 pietra antica - 55 grigio - 54 nero - 53 terra - 52 bianco - 51 avena
 * (u.s.i.) until stock lasts

164
 165



Master 500

two-bowl sink with draining area
 Dimension: **1160 x 500 mm**
 Built-in hole: **1140 x 480 mm**



Inset

MATERIAL	CODE
Metaltek	LMM500
Granitek	LGM500



To complete your order add the colour number chosen at the end of the code.

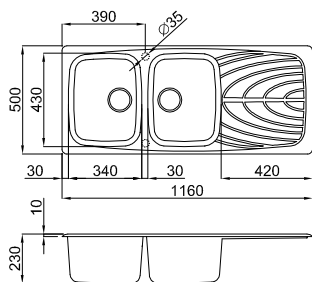

Accessories see page 169:

04 05 09 17 19 25 42 64 140 146 147 148

Packaging:
 carton and polystyrene, m³ 0,20 approx.

Kit of the sink:
 space-saving siphon,
 wastes and pre-mounted hooks.

Available colours: MASTER 500 (see inside cover pages)
Metaltek: 79 aluminium - 77 chromium - 73 titanium - 72 rame - *71 alluminio u.s.i. - 70 ghisa
Granitek: *74 avrelle u.s.i. - 68 bianco titano - 62 bianco antico - 61 pietra antica - 59 antracite
 58 grigio ambrà u.s.i. - 57 pietra vecchia - 55 grigio - 54 nero - 53 terra - 52 bianco - 51 avena - 41 cacao - 40 full black
 * (u.s.i.) until stock lasts

Master 475

one and half bowl sink with draining area

Dimension: 1000 x 500 mm

Built-in hole: 980 x 480 mm

MATERIAL	CODE
Metaltek	LMM475
Granitek	LGM475



Inset

To complete your order add the colour number chosen at the end of the code.

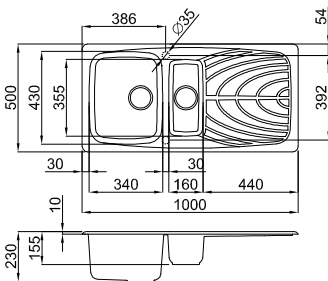

Accessories see page 169:

04 05 09 14 17 19 25 42 64 140 146 147 148

Packaging:

carton and polystyrene, m³ 0,17 approx.

Kit of the sink:

space-saving siphon, wastes and pre-mounted hooks.

14



AVP01301
Polycarbonate
bowl

Available colours: MASTER 475 (see inside cover pages)

Metaltek: 79 aluminium - 77 chromium - 73 titanium - 72 rame - *71 alluminio u.s.i. - 70 ghisa

Granitek: *74 avrelle u.s.i. - 68 bianco titano - 62 bianco antico - 61 pietra antica

59 antracite - *58 grigio ambra u.s.i. - 57 pietra vecchia - 55 grigio - 54 nero

53 terra - 52 bianco - 51 avena - 41 cacao - 40 full black

* (u.s.i.) until stock lasts

Master 450

two-bowl sink

Dimension: 860 x 500 mm

Built-in hole: 840 x 480 mm

MATERIAL	CODE
Metaltek	LMM450
Granitek	LGM450



Inset

To complete your order add the colour number chosen at the end of the code.

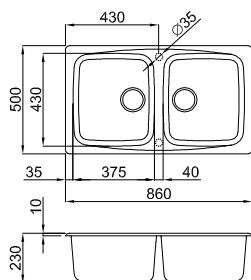

Accessories see page 169:

04 05 09 17 19 25 65 140 146 147 148

Packaging:

carton and polystyrene, m³ 0,15 approx.

Kit of the sink:

space-saving siphon,
wastes and pre-mounted hooks.

Available colours: MASTER 450 (see inside cover pages)

Metaltek: 79 aluminium - 77 chromium - 73 titanium - 72 rame - 70 ghisa

Granitek: *74 avrelle u.s.i. - *69 vaniglia u.s.i. - 68 bianco titano - 62 bianco antico - 61 pietra antica - 59 antracite

*58 grigio ambra u.s.i. - 57 pietra vecchia - 55 grigio - 54 nero - 53 terra - 52 bianco - 51 avena - 41 cacao - 40 full black

* (u.s.i.) until stock lasts



Inset

Master 400

one-bowl sink with draining area

Dimension: **860 x 500 mm**
Built-in hole: **840 x 480 mm**

MATERIAL	CODE
Metaltek	LMM400
Granitek	LGM400



To complete your order add the colour number chosen at the end of the code.

Accessories see page 169:

04 05 09 17 19 25 42 64 141 146 147 149

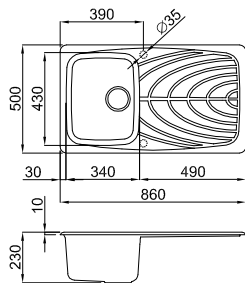

Packaging:

carton and polystyrene, m³ 0,15 approx.

Kit of the sink:

space-saving siphon, wastes and pre-mounted hooks.

Available colours: MASTER 400 (see inside cover pages)

Metaltek: 79 aluminium - 77 chromium - 73 titanium - 72 rame - 70 ghisa

Granitek: *74 avrelle u.s.l. - *69 vaniglia u.s.l. - 68 bianco titano

62 bianco antico - 61 pietra antica - 59 antracite - *58 grigio ambra u.s.l.

57 pietra vecchia - 55 grigio - 54 nero - 53 terra - 52 bianco - 51 avena

41 cacao - 40 full black

* (u.s.l.) until stock lasts

166
167



*When it starts the composition



Inset

Master 350

two-bowl sink

Dimension: **790 x 500 mm**
Built-in hole: **770 x 480 mm**

MATERIAL	CODE
Metaltek	LMM350
Granitek	LGM350
Sintek	LSM350
Sintek 12 t.d.f.	LSM35012



To complete your order add the colour number chosen at the end of the code.

Accessories see page 169:

04 05 09 17 19 25 64 140 146 147 148

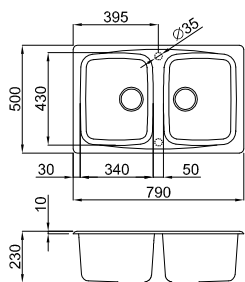

Packaging:

carton and polystyrene, m³ 0,13 approx.

Kit of the sink:

space-saving siphon, wastes and pre-mounted hooks.

Available colours: MASTER 350 (see inside cover pages)

Metaltek: 79 aluminium - 77 chromium - 73 titanium - 72 rame - 70 ghisa

Granitek: *74 avrelle u.s.l. - *69 vaniglia u.s.l. - 68 bianco titano - 62 bianco antico - 61 pietra antica - 59 antracite

57 pietra vecchia - 55 grigio - 54 nero - 53 terra - 52 bianco - 51 avena - 41 cacao - 40 full black

Sintek: 14 bianco antico - 13 nero - 12 terra di francia - 11 bianco

* (u.s.l.) until stock lasts

Master 300

one-bowl sink with draining area

Dimension: 790 x 500 mm

Built-in hole: 770 x 480 mm

MATERIAL	CODE
Metaltek	LMM300
Granitek	LGM300



Inset

To complete your order add the colour number chosen at the end of the code.

Accessories see page 169:

04 05 09 17 19 25 42 64 141 146 147 149

Packaging:

carton and polystyrene, m³ 0,13 approx.

Kit of the sink:

space-saving siphon, wastes and pre-mounted hooks.

Available colours: **MASTER 300** (see inside cover pages)

Metaltek: 79 aluminium - 77 chromium - 73 titanium - 72 rame

*71 alluminio u.s.l. - 70 ghisa

Granitek: *74 avrelle u.s.l. - 68 bianco titano - 62 bianco antico

61 pietra antica - 59 antracite - *58 grigio ambra u.s.l. - 57 pietra vecchia

55 grigio - 54 nero - 53 terra - 52 bianco - 51 avena - 41 cacao - 40 full black

* (u.s.l.) until stock lasts

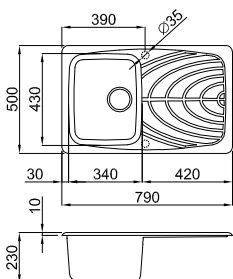

Master CORNER

two-bowl sink with draining area

Dimension: 830 x 830 mm

MATERIAL	CODE
Metaltek	LMMCOR
Granitek	LGMCOR
Sintek	LSMCOR
Sintek 12 t.d.f.	LSMCOR12

To complete your order add the colour number chosen at the end of the code.



equipped with mixer hole



Inset

Accessories see page 169:

04 05 09 17 19 25 140 146 147 148

Packaging:

carton and polystyrene, m³ 0,23 approx.

Kit of the sink:

space-saving siphon, wastes and pre-mounted hooks.

Built-in hole:

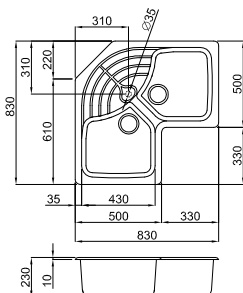
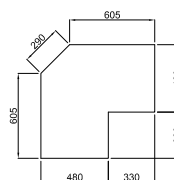

Available colours: **MASTER CORNER** (see inside cover pages)

Metaltek: 79 aluminium - 77 chromium - 73 titanium - 72 rame - 70 ghisa

Granitek: *76 hamada u.s.l. - *74 avrelle u.s.l. - *69 vaniglia u.s.l. - 68 bianco titano - 62 bianco antico - 61 pietra antica

59 antracite - *58 grigio ambra u.s.l. - 57 pietra vecchia - 55 grigio - 54 nero - 53 terra - 52 bianco - 51 avena - 41 cacao - 40 full black

Sintek: 14 bianco antico - 13 nero - 12 terra di francia - 11 bianco

* (u.s.l.) until stock lasts

168
169



SUGGESTED MIXERS



Suggested accessories **Master** collection

A richer and studied accessories outfit features our sink proposals.

For each of our model a accessories series is provided for enriching the aesthetics and functionality of our sinks.

We studied integrated systems of accessories, which exploit each of your movement.



ATL01000
Sliding wooden chopping board

04



AVI03001
Colander

05

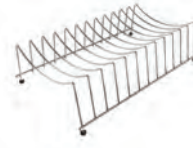

ADI01300
Dish drainer

09



ACI01301
Basket

17

Dim.: 446 x 352 mm



ATP03300
Wooden chopping board

19



ADI02300
Round soap dispenser

25



ARI01300
Rollmat

42

new

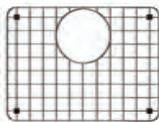

AGB01301
Bottom grid std S

64

new

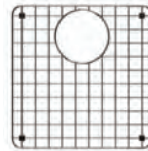

AGB01302
Bottom grid std M

65



ASP23000
Pop-up waste 2 ways - 3,5" round strainer plug and square control knob

140



ASP13000
Pop-up waste 1 way - 3,5" round strainer plug and square control knob

141

new



ACPM1000
Manual waste cover

146



ACPA1000
Pop-up waste cover

147

new



APM2VSCTPGO
Euro 105
Piletta 3,5"
2 vie ottonata

148

new



APM1VCTPGO
Euro 59
Piletta 3,5"
1 via ottonata

149

170
171

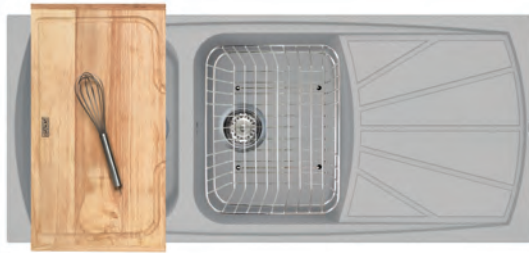

LIVING

COLLECTION

Living 500
two-bowl sink with draining area

Living 475
one and half bowl sink with draining area

Living 450
two-bowl sink

Living 400
one-bowl sink with draining area

Living 300
one-bowl sink with draining area

Living 125
one-bowl sink with draining area

A simple and functional design.

A classic sinks collection which, through its simplicity and the numerous dimensions available, makes the environment perfectly functional. Each model can be equipped with many accessories and the many colours.



172
173



Inset:

The rim of the sink after installation appears on the worktop.



New accessory: waste cover.

- SPACE-SAVING SIPHON
- OVERFLOW ELLECI
- PRE-MOUNTED HOOKS



Elleci sinks have a **TOTAL ANTIBACTERIAL PROTECTION**, which has an adequate antibacterial coverage of the mass. In this way the bacterial organisms are repelled. Reliability and practicality become a certainty every day in the kitchen.





Living 500

two-bowl sink with draining area
 Dimension: **1160 x 500 mm**
 Built-in hole: **1140 x 480 mm**

MATERIAL	CODE
Metaltek	LML500
Granitek	LGL500
Sintek	LSL500
Sintek 12 t.d.f.	LSL50012

To complete your order add the colour number chosen at the end of the code.

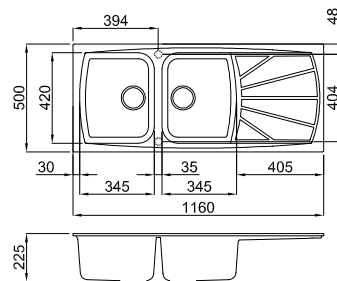

Accessories see page 179:

04 09 17 25 42 62 64 140 146 147 148

Packaging:

carton and polystyrene, m³ 0,20 approx.

Kit of the sink:

space-saving siphon, wastes and pre-mounted hooks.

Available colours: LIVING 500 (see inside cover pages)

Metaltek: 79 aluminium - 77 chromium - 73 titanium - 72 rame

*71 alluminio u.s.i. - 70 ghisa

Granitek: *76 hamada u.s.i. - *69 vaniglia u.s.i. - 68 bianco titano

62 bianco antico - 61 pietra antica - 59 antracite - *58 grigio ambra u.s.i.

57 pietra vecchia - 55 grigio - 54 nero - 53 terra - 52 bianco - 51 avena

41 cacao - 40 full black

Sintek: 14 bianco antico - 13 nero - 12 terra di francia - 11 bianco

* (u.s.i.) until stock lasts

174
175



Living 475

one and half bowl sink with draining area
 Dimension: **1000 x 500 mm**
 Built-in hole: **980 x 480 mm**

MATERIAL	CODE
Metaltek	LML475
Granitek	LGL475
Sintek	LSL475
Sintek 12 t.d.f.	LSL47512

To complete your order add the colour number chosen at the end of the code.

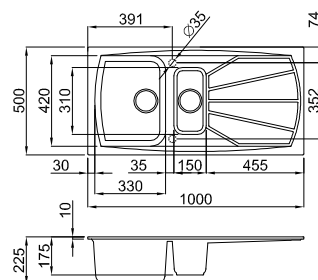

Accessories see page 179:

04 09 14 17 25 42 62 64 140 146 147 148

Packaging:

carton and polystyrene, m³ 0,17 approx.

Kit of the sink:

space-saving siphon, wastes and pre-mounted hooks.



AVP01301
Polycarbonate bowl

14

Available colours: LIVING 475 (see inside cover pages)

Metaltek: 79 aluminium - 77 chromium - 73 titanium - 72 rame - *71 alluminio u.s.i. - 70 ghisa

Granitek: *76 hamada u.s.i. - *74 avrelle u.s.i. - *69 vaniglia u.s.i. - 68 bianco titano - 62 bianco antico - 61 pietra antica

59 antracite - *58 grigio ambra u.s.i. - 57 pietra vecchia - 55 grigio - 54 nero - 53 terra - 52 bianco - 51 avena

41 cacao - 40 full black

Sintek: 14 bianco antico - 13 nero - 12 terra di francia - 11 bianco

* (u.s.i.) until stock lasts

Living 450

two-bowl sink

Dimension: 860 x 500 mm

Built-in hole: 840 x 480 mm

MATERIAL	CODE
Metaltek	LML450
Granitek	LGL450
Sintek	LSL450
Sintek 12 t.d.f.	LSL45012

To complete your order add the colour number chosen at the end of the code.

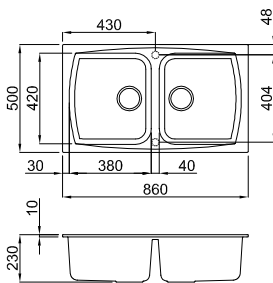

Accessories see page 179:

04 09 17 25 62 65 140 146 147 148

Packaging:

carton and polystyrene, m³ 0,15 approx.

Kit of the sink:

space-saving siphon, wastes and pre-mounted hooks.

Available colours: LIVING 450 (see inside cover pages)

Metaltek: 79 aluminium - 77 chromium - 73 titanium - 72 rame

*71 alluminio u.s.l. - 70 ghisa

Granitek: *76 hamada u.s.l. - *74 avrelle u.s.l. - *69 vaniglia u.s.l.

68 bianco titano - 62 bianco antico - 61 pietra antica - 59 antracite

*58 grigio ambra u.s.l. - 57 pietra vecchia - 55 grigio - 54 nero

53 terra - 52 bianco - 51 avena - 41 cacao - 40 full black

Sintek: 14 bianco antico - 13 nero - 12 terra di francia - 11 bianco

* (u.s.l.) until stock lasts

Living 400

one-bowl sink with draining area

Dimension: 860 x 500 mm

Built-in hole: 840 x 480 mm

MATERIAL	CODE
Metaltek	LML400
Granitek	LGL400
Sintek	LSL400
Sintek 12 t.d.f.	LSL40012

To complete your order add the colour number chosen at the end of the code.

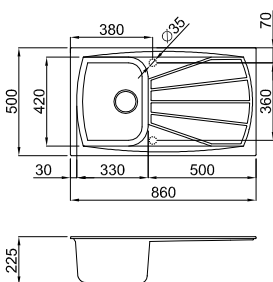

Accessories see page 179:

04 09 17 25 42 62 64 141 146 147 149

Packaging:

carton and polystyrene, m³ 0,15 approx.

Kit of the sink:

space-saving siphon, wastes and pre-mounted hooks.

Available colours: LIVING 400 (see inside cover pages)

Metaltek: 79 aluminium - 77 chromium - 73 titanium - 72 rame - *71 alluminio u.s.l. - 70 ghisa

Granitek: *76 hamada u.s.l. - *74 avrelle u.s.l. - *69 vaniglia u.s.l. - 68 bianco titano - 62 bianco antico - 61 pietra antica

59 antracite - *58 grigio ambra u.s.l. - 57 pietra vecchia - 55 grigio - 54 nero - 53 terra - 52 bianco - 51 avena

41 cacao - 40 full black

Sintek: 14 bianco antico - 13 nero - 12 terra di francia - 11 bianco

* (u.s.l.) until stock lasts



Inset

Living 300

one-bowl sink with draining area

Dimension: **790 x 500 mm**

Built-in hole: **770 x 480 mm**

MATERIAL	CODE
Metatek	LML300
Granitek	LGL300
Sintek	LSL300
Sintek 12 t.d.f.	LSL30012

To complete your order add at the end of the code the number of the chosen colour.

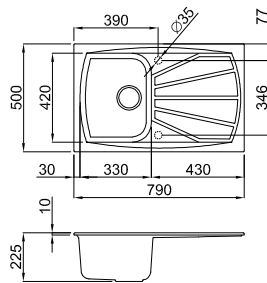

Accessories see page 179:

04 09 17 25 42 62 64 141 146 147 149

Packaging:

carton and polystyrene, m³ 0,13 approx.

Kit of the sink:

space-saving siphon, wastes and pre-mounted hooks.

Available colours: LIVING 300 (see inside cover pages)

Metatek: 79 aluminium - 77 chromium - 73 titanium - 72 rame

*71 alluminio u.s.l. - 70 ghisa

Granitek: *74 avrelle u.s.l. - *69 vaniglia u.s.l. - 68 bianco titano

62 bianco antico - 61 pietra antica - 59 antracite - *58 grigio ambra u.s.l.

57 pietra vecchia - 55 grigio - 54 nero - 53 terra - 52 bianco - 51 avena

41 cacao - 40 full black

Sintek: 14 bianco antico - 13 nero - 12 terra di francia - 11 bianco

* (u.s.l.) until stock lasts

176
177



Inset

Living 125

one-bowl sink with draining area

Dimension: **610 x 500 mm**

Built-in hole: **595 x 490 mm**

MATERIAL	CODE
Metatek	LML125
Granitek	LGL125
Sintek	LSL125
Sintek 12 t.d.f.	LSL12512

To complete your order add the colour number chosen at the end of the code.

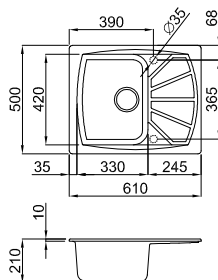

Accessories see page 179:

04 09 17 25 42 62 64 141 146 147 149

Packaging:

carton and polystyrene, m³ 0,11 approx.

Kit of the sink:

space-saving siphon, wastes and pre-mounted hooks.

Available colours: LIVING 125 (see inside cover pages)

Metatek: 79 aluminium - 77 chromium - 73 titanium - 72 rame - *71 alluminio u.s.l. - 70 ghisa

Granitek: *76 hamada u.s.l. - *74 avrelle u.s.l. - *69 vaniglia u.s.l. - 68 bianco titano - 62 bianco antico - 61 pietra antica

59 antracite - *58 grigio ambra u.s.l. - 57 pietra vecchia - 55 grigio - 54 nero - 53 terra - 52 bianco - 51 avena

41 cacao - 40 full black

Sintek: 14 bianco antico - 13 nero - 12 terra di francia - 11 bianco

* (u.s.l.) until stock lasts



178
179

SUGGESTED MIXERS

Chrome



STREAM
code MIKSTRCR

51 avena



RIO
code MGKRIO51

72 rame



VENERE
code MMKVEN72

Suggested accessories **Living** collection

A richer and studied accessories outfit features our sink proposals.

For each of our model a accessories series is provided for enriching the aesthetics and functionality of our sinks.

We studied integrated systems of accessories, which exploit each of your movement.



ATL01000
Sliding wooden chopping board

04

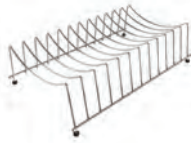

ADI01300
Dish drainer

09



ACI01301
Basket

17



ADI02300
Round soap dispenser

25

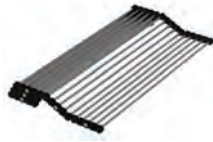

ARI01300
Rollmat

42

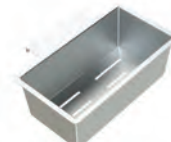

AVI03306
Colander 475 std S

62

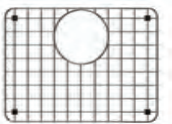

AGB01301
Bottom grid std S

64

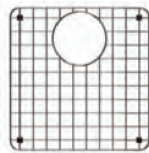

AGB01302
Bottom grid std M

65



ASP23000
Pop-up waste 2 ways - 3,5" round strainer plug and square control knob

140



ASP13000
Pop-up waste 1 way - 3,5" round strainer plug and square control knob

141



ACPM1000
Manual waste cover

146



ACPA1000
Pop-up waste cover

147



APM2VCTPGO
Euro 105
Piletta 3,5"
2 vie ottonata

148



APM1VCTPGO
Euro 59
Piletta 3,5"
1 via ottonata

149



STAINLESS STEEL

COLLECTION

River

Inset

Sky

Inset

W-Square

Inset - Undermount - Flushmount

Square

Inset - Undermount

Square R14

Inset - Undermount

Space R15

Undermount

Space R50

Undermount

Special

Inset - Undermount

River Collection

River 500

two-bowl sink with draining area

River 475

one and half bowl sink with draining area

River 450

two-bowl sink

River 400

one-bowl sink with draining area

River 350

two-bowl sink

River 300

one-bowl sink with draining area

River CORNER

two-bowl sink with draining area

A versatile collection suitable for most different requirements, always offering the best functionality.

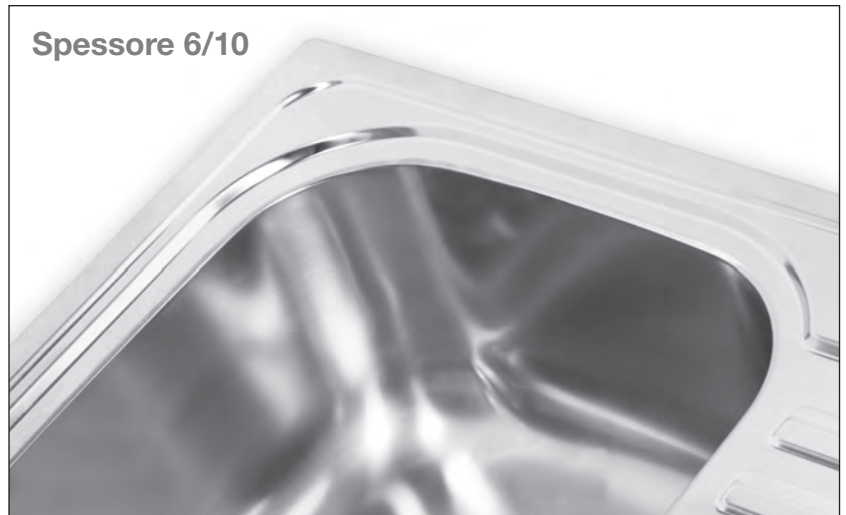

Spessore 6/10

River Collection, built-in, stainless steel AISI 304 18/10.

182
183



Satin finish: matt but shining, the **satin steel** for years keeps unaltered its elegance values, hygiene and resistance to daily wear and tear.



Antiscratch finish: surface is worked in a particular texture conferring to it a high abrasions resistance.

Production of “authentic” steel sinks.

Our sinks are made of genuine stainless steel **18/10**: ideal ratio between **chrome** and **nickel**.

Chrome makes the steel hard, it stands wear and tear and the nickel increases the impacts resistance.



New accessory: waste cover.



Inset:

The rim of the sink after installation appears on the worktop.



Depth bowl:

190 - 195 mm.





800

Base



Inset

River 500

two-bowl sink with draining area

Dimension: **1160 x 500 mm**

Built-in hole: **1135 x 475 mm**

FINISH	CODE
Satin	LIR500SACDX
Satin	LIR500SASDX
Satin	LIR500SACSX
Satin	LIR500SASSX
Anti-scratch	LIR500ANCDX
Anti-scratch	LIR500ANSDX
Anti-scratch	LIR500ANCSX
Anti-scratch	LIR500ANSSX



Accessories see page 189:

04 09 17 24 32 33 146

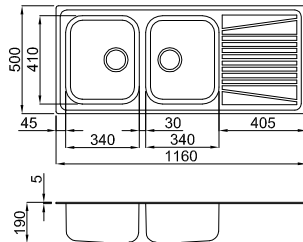

Sink kit:

waste drainers 3^{1/2}, space saving-siphon, fixing hooks and sealant.

equipped with mixer hole

Packaging type:

C: carton packaging

S: bag packaging

DX: right bowl

SX: left bowl

184
185



600

Base



Inset

River 475

one and half bowl sink with draining area

Dimension: **1000 x 500 mm**

Built-in hole: **975 x 475 mm**

FINISH	CODE
Satin	LIR475SACDX
Satin	LIR475SASDX
Satin	LIR475SACSX
Satin	LIR475SASSX
Anti-scratch	LIR475ANCDX
Anti-scratch	LIR475ANSDX
Anti-scratch	LIR475ANCSX
Anti-scratch	LIR475ANSSX



Accessories see page 189:

04 09 17 24 32 33 146

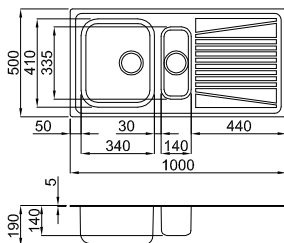

Sink kit:

waste drainers 3^{1/2}, space saving-siphon, fixing hooks and sealant.

equipped with mixer hole

Packaging type:

C: carton packaging

S: bag packaging

DX: right bowl

SX: left bowl

elleci river

River 450

two-bowl sink

Dimension: 860 x 500 mm

Built-in hole: 835 x 475 mm

FINISH	CODE
Satin	LIR450SAC
Satin	LIR450SAS
Anti-scratch	LIR450ANC
Anti-scratch	LIR450ANS



*When it starts the composition



Inset

Accessories see page 189:

04 09 17 24 32 33 146

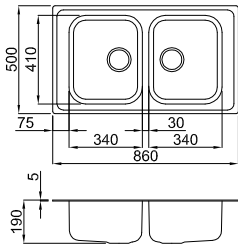

Sink kit:

waste drainers 3¹/₂, space saving-siphon, fixing hooks and sealant.

equipped with mixer hole

Packaging type:

C: carton packaging

S: bag packaging

River 400

one-bowl sink with draining area

Dimension: 860 x 500 mm

Built-in hole: 835 x 475 mm

FINISH	CODE
Satin	LIR400SACDX
Satin	LIR400SASDX
Satin	LIR400SACSX
Satin	LIR400SASSX
Anti-scratch	LIR400ANCDX
Anti-scratch	LIR400ANSDX
Anti-scratch	LIR400ANCSX
Anti-scratch	LIR400ANSSX



Inset

Accessories see page 189:

04 09 17 24 32 33 146

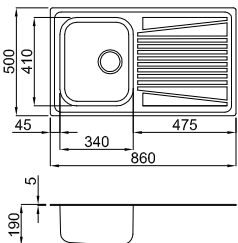

Sink kit:

waste drainers 3¹/₂, space saving-siphon, fixing hooks and sealant.

equipped with mixer hole

Packaging type:

C: carton packaging

S: bag packaging

DX: right bowl

SX: left bowl



*When it starts the composition



Inset

River 350

two-bowl sink

Dimension: **790 x 500 mm**
Built-in hole: **765 x 475 mm**

FINISH	CODE
Satin	LIR350SAC
Satin	LIR350SAS
Anti-scratch	LIR350ANC
Anti-scratch	LIR350ANS



Accessories see page 189:

04 09 17 24 32 33 146

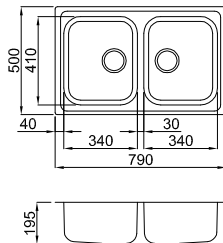

Sink kit:

waste drainers 3^{1/2}, space saving-siphon, fixing hooks and sealant.

equipped with mixer hole

Packaging type:

C: carton packaging
S: bag packaging

186
187

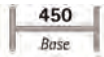

Inset

River 300

one-bowl sink with draining area

Dimension: **790 x 500 mm**
Built-in hole: **765 x 475 mm**

FINISH	CODE
Satin	LIR300SACDX
Satin	LIR300SASDX
Satin	LIR300SACSX
Satin	LIR300SASSX
Anti-scratch	LIR300ANCDX
Anti-scratch	LIR300ANSDX
Anti-scratch	LIR300ANCSX
Anti-scratch	LIR300ANSSX



Accessories see page 189:

04 09 17 24 32 33 146

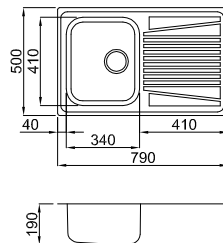

Sink kit:

waste drainers 3^{1/2}, space saving-siphon, fixing hooks and sealant.

equipped with mixer hole

Packaging type:

C: carton packaging
S: bag packaging
DX: right bowl
SX: left bowl

River CORNER

two-bowl sink with draining area

Dimension: 830 x 830 mm

FINISH	CODE
Satin	LIRCORSAC
Anti-scratch	LIRCORANC

Accessories see page 189:

04 09 17 24 32 33 146

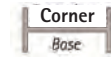
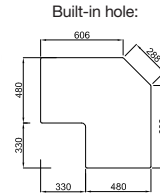
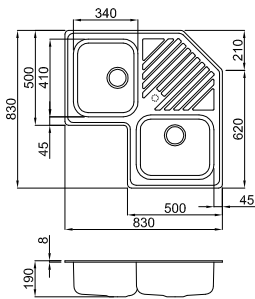

Sink kit:
waste drainers 3¹/₂, space saving-siphon,
fixing hooks and sealant.

equipped with mixer hole

Packaging type:
C: carton packaging

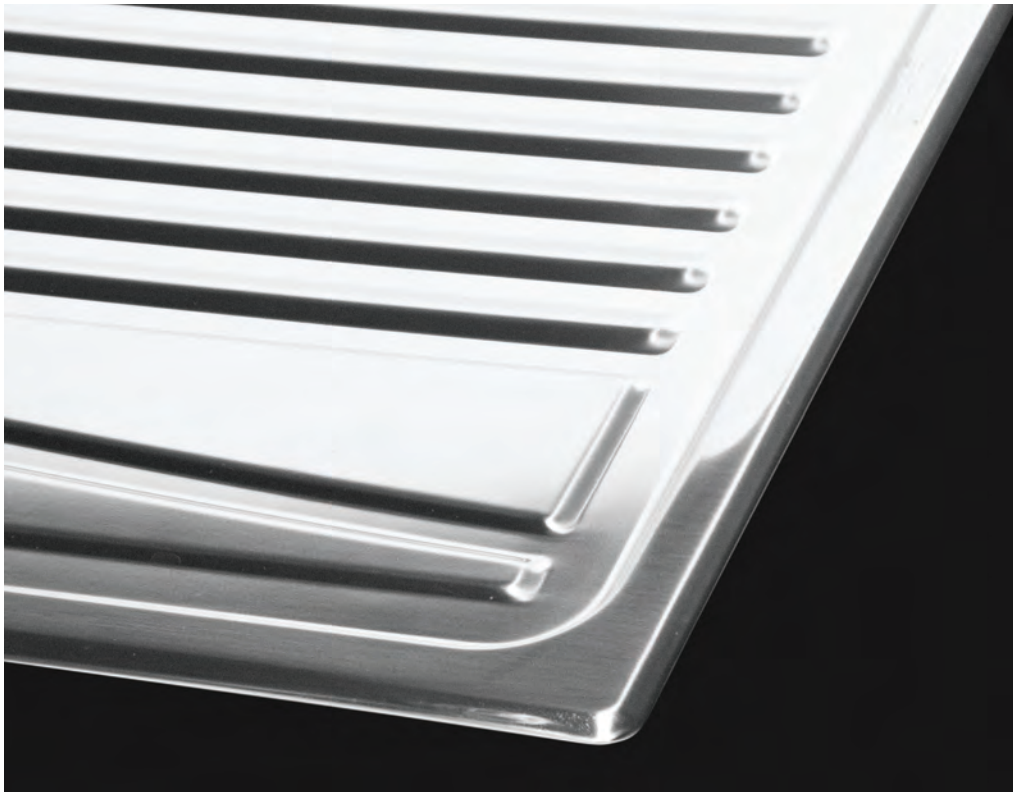



188
189

Suggested accessories **River** collection

A richer and studied accessories outfit features our sink proposals.

For each of our model a accessories series is provided for enriching the aesthetics and functionality of our sinks.

We studied integrated systems of accessories, which exploit each of your movement.



ATL01000
Sliding wooden chopping board

04

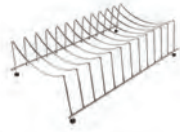

ADI01300
Dish drainer

09



ACI01301
Basket

17



ATV01001
Glass sliding chopping board

24



DLA01600
Antiscale

32



DLI01600
Active inox

33

new



ACPM1000
Manual waste cover

146



SUGGESTED MIXERS



STREAM
code MIKSTRCR

new



STREAM PLUS
code MIKSTPCR

new



RENO PLUS
code MIKREPCR

new

Sky Collection

For all kitchen planet.
Pure and simple design fitting all furniture styles.

Sky 550

two and half bowl sink

Sky 500

two-bowl sink with draining area

Sky 480

one-bowl sink with draining area

Sky 475

one and half bowl sink with draining area

Sky 450

two-bowl sink

Sky 400

one-bowl sink with draining area

Sky 360

one-bowl sink

Sky 350

two-bowl sink

Sky 300

one-bowl sink with draining area

Sky CORNER

two-bowl sink with draining area

Sky ROUND 510

one-bowl sink

Sky ROUND 435

one-bowl sink

Spessore 6/10



Sky Collection, builtin, stainless steel AISI 304 18/10.



Satin finish: matt but shining, the **satin steel** for years keeps unaltered its elegance values, hygiene and resistance to daily wear and tear.

Production of "authentic" steel sinks.

Our sinks are made of genuine stainless steel **18/10**: ideal ratio between **chrome** and **nickel**.

Chrome makes the steel hard, it stands wear and tear and the nickel increases the impacts resistance.

190
191



New accessory: waste cover.



Inset:

The rim of the sink after installation appears on the worktop.



Depth bowl:

170 - 220 mm.



Stainless Steel
Sinks



Sky 550

two and half bowl sink
 Dimension: **980 x 500 mm**
 Built-in hole: **960 x 480 mm**



FINISH	CODE
Satin	LIK550SAC



Accessories see page 199:

04 09 14 24 30 32 33 146

equipped with mixer hole

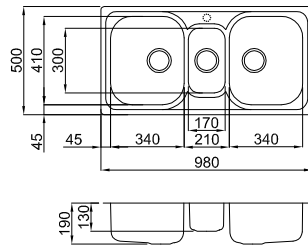

Sink kit:
 waste drainers 3^{1/2}, space saving-siphon,
 fixing hooks and sealant.

Packaging type:
C: carton packaging



AVP01301
 Polycarbonate
 bowl

14

192
193



Sky 500

two-bowl sink with draining area
 Dimension: **1160 x 500 mm**
 Built-in hole: **1140 x 480 mm**



FINISH	CODE
Satin	LIK500SACDX
Satin	LIK500SACSX



Accessories see page 199:

04 09 24 30 32 33 146

equipped with mixer hole

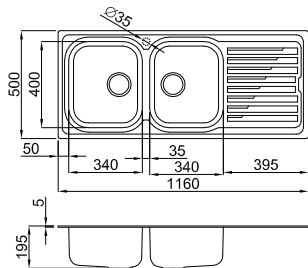

Sink kit:
 waste drainers 3^{1/2}, space saving-siphon,
 fixing hooks and sealant.

Packaging type:
C: carton packaging
DX: right bowl
SX: left bowl

Sky 480

one-bowl sink with draining area

Dimension: 1000 x 500 mm

Built-in hole: 980 x 480 mm

FINISH	CODE
Satin	LIK480SACDX
Satin	LIK480SACSX



Accessories see page 199:

04 09 24 30 32 33 146

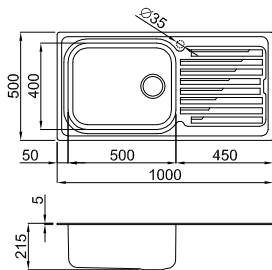

Sink kit:

waste drainers 3^{1/2}, space saving-siphon, fixing hooks and sealant.

equipped with mixer hole

Packaging type:

C: carton packaging

DX: right bowl

SX: left bowl

Sky 475

one and half bowl sink with draining area

Dimension: 1000 x 500 mm

Built-in hole: 980 x 480 mm

FINISH	CODE
Satin	LIK475SACDX
Satin	LIK475SACSX

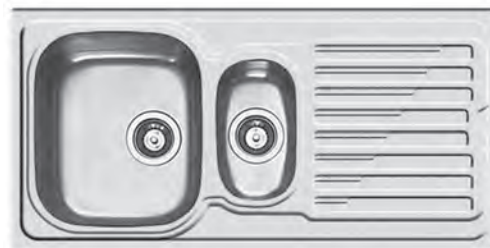

* When it starts the composition



Accessories see page 199:

04 09 14 24 30 32 33 146

equipped with mixer hole

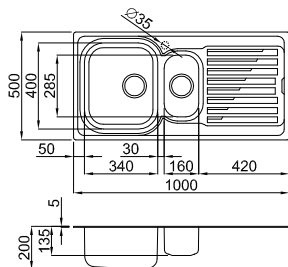

Sink kit:

waste drainers 3^{1/2}, space saving-siphon, fixing hooks and sealant.

Packaging type:

C: carton packaging

DX: right bowl

SX: left bowl



AVP01301
Polycarbonate bowl

14



*When it starts the composition



Inset

Sky 450

two-bowl sink

Dimension: **860 x 500 mm**
Built-in hole: **840 x 480 mm**

FINISH	CODE
Satin	LIK450SAC



Accessories see page 199:

04 09 24 30 32 33 146

Sink kit:

waste drainers 3^{1/2}, space saving-siphon, fixing hooks and sealant.

equipped with mixer hole

Packaging type:

C: carton packaging

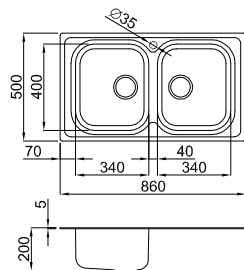

194
195

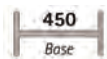

Inset

Sky 400

one-bowl sink with draining area

Dimension: **860 x 500 mm**
Built-in hole: **840 x 480 mm**

FINISH	CODE
Satin	LIK400SACDX
Satin	LIK400SACSX



Accessories see page 199:

04 09 24 30 32 33 146

Sink kit:

waste drainers 3^{1/2}, space saving-siphon, fixing hooks and sealant.

equipped with mixer hole

Packaging type:

C: carton packaging

DX: right bowl

SX: left bowl

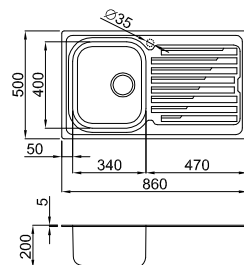

Sky 360

one-bowl sink

Dimension: 860 x 500 mm
Built-in hole: 840 x 480 mm

FINISH	CODE
Satin	LIK360SAC



Inset

Accessories see page 199:

09 32 33 46 47 48 146



46 ATL01303
Wooden chopping board
Sky 360



47 AVI03002
Bowl
Sky 360

Sink kit:

waste drainers 3¹/₂,
space saving-siphon,
fixing hooks and sealant.

Packaging type:

C: carton packaging

equipped with mixer hole



48 AVP01302
Polycarbonate bowl
Sky 360



49 ACI01305
Basket
Sky 360

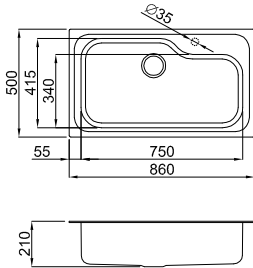

Sky 350

two-bowl sink

Dimension: 790 x 500 mm
Built-in hole: 770 x 480 mm

FINISH	CODE
Satin	LIK350SAC



*When it starts the composition



Inset

Accessories see page 199:

04 09 24 30 32 33 146

Sink kit:

waste drainers 3¹/₂, space saving-siphon,
fixing hooks and sealant.

equipped with mixer hole

Packaging type:

C: carton packaging

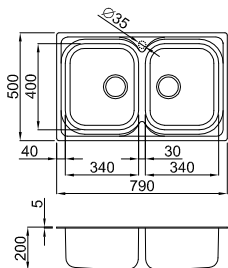



Sky 300

one-bowl sink with draining area
Dimension: 790 x 500 mm
Built-in hole: 770 x 480 mm



FINISH	CODE
Satin	LIK300SACDX
Satin	LIK300SACSX

Accessories see page 199:

04 09 24 30 32 33 146

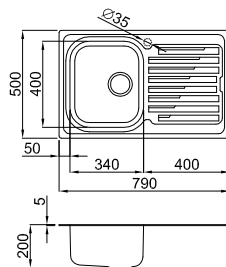

Sink kit:

waste drainers 3¹/₂, space saving-siphon, fixing hooks and sealant.

equipped with mixer hole

Packaging type:

C: carton packaging

DX: right bowl

SX: left bowl

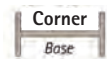

Sky CORNER

two-bowl sink with draining area
Dimension: 830 x 830 mm



Built-in hole:

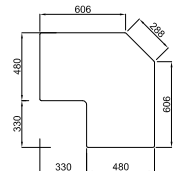

FINISH	CODE
Satin	LIKCOR SACDX
Satin	LIKCOR SACSX

Accessories see page 199:

04 09 24 30 32 33 146

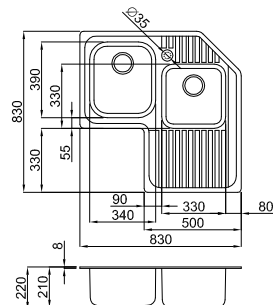

Sink kit:

waste drainers 3¹/₂, space saving-siphon, fixing hooks and sealant.

equipped with mixer hole

Packaging type:

C: carton packaging

DX: right bowl

SX: left bowl

Sky ROUND 510

one-bowl sink

Dimension: \varnothing 510 mm
Built-in hole: \varnothing 490 mm

FINISH	CODE
Satin	LIKROUSAC51



*When it starts the composition



ACI02301
Basket
Round



ATL02301
Wooden
chopping board
Round

Accessories see page 199:

09 15 16 32 33 146

15

16

Sink kit:

waste drainers $3\frac{1}{2}$, space saving-siphon, fixing hooks and sealant.

equipped with mixer hole

Packaging type:

C: carton packaging

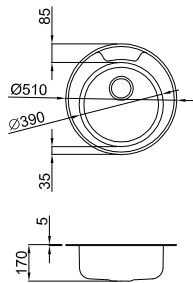

Sky ROUND 435

one-bowl sink

Dimension: \varnothing 435 mm
Built-in hole: \varnothing 415 mm

FINISH	CODE
Satin	LIKROUSAC



ACI02301
Basket
Round



ATL02301
Wooden
chopping board
Round

Accessories see page 199:

09 15 16 32 33 146

15

16

Sink kit:

waste drainers $3\frac{1}{2}$, space saving-siphon, fixing hooks and sealant.

Mixer installation
on worktop

Packaging type:

C: carton packaging

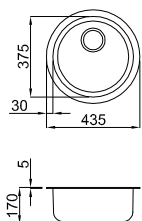



198
199



Suggested accessories **Sky** collection

A richer and studied accessories outfit features our sink proposals.

For each of our model a accessories series is provided for enriching the aesthetics and functionality of our sinks.

We studied integrated systems of accessories, which exploit each of your movement.



ATL01000
Sliding wooden chopping board

04

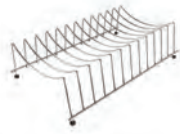

ADI01300
Dish drainer

09



ATV01001
Glass sliding chopping board

24



ACI01304
Basket drainer

30



DLA01600
Antiscale

32



DLI01600
Active inox

33

new



ACPM1000
Manual waste cover

146



SUGGESTED MIXERS



DOVE PLUS
code MIKDOPCR

new



STREAM PLUS
code MIKSTPCR

new



CHEF
code MIKCHECR

W-Square Collection

W-Square 700
one-bowl sink

W-Square 500
one-bowl sink

W-Square 450
one-bowl sink

W-Square 400
one-bowl sink

W-Square 340
one-bowl sink

Square waste



Deep bowls and high thicknesses. Sinks with sharp corners for an easier cleaning. New collection featured by 25 Ray and square waste, a more winning aesthetics.



WSquare new collection with square waste, undermounted and flush mount, stainless steel AISI 304 18/10.



Satin finish: matt but shining, the **satin steel** for years keeps unaltered its elegance values, hygiene and resistance to daily wear and tear.

Production of “authentic” steel sinks.

Our sinks are made of genuine stainless steel **18/10**: ideal ratio between **chrome** and **nickel**.

Chrome makes the steel hard, it stands wear and tear and the nickel increases the impacts resistance.



Flushmount:

The rim of the sink appears at exactly the same level with the worktop.



Undermount:

The rom of the sink appears underneath the woktop.



Inset:

The rim of the sink after installation appears on the worktop.



Depth bowl:

200 mm.



Stainless Steel
Sinks



W-Square 700

one-bowl sink

Dimension: 740 x 440 mm

Built-in hole:

inset: 720 x 420 mm

undermount: 700 x 400 mm - R25

flushmount: 728 x 428 mm - R25



Inset



Undermount



Flushmount

FINISH	CODE
Satin	LIW700SACMU



Accessories see page 204:

06 09 17 32 33 54

Sink kit:

waste drainers 3^{1/2}, space saving-siphon and hooks.

Packaging type:

C: carton packaging

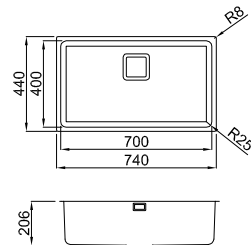

202
203



W-Square 500

one-bowl sink

Dimension: 540 x 440 mm

Built-in hole:

inset: 520 x 420 mm

undermount: 500 x 400 mm - R25

flushmount: 528 x 428 mm - R25



Inset



Undermount



Flushmount

FINISH	CODE
Satin	LIW500SACMU



Accessories see page 204:

06 09 17 32 33 54

Sink kit:

waste drainers 3^{1/2}, space saving-siphon and hooks.

Packaging type:

C: carton packaging

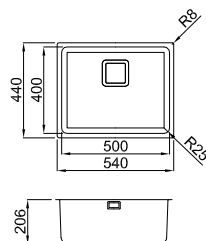

W-Square 450

one-bowl sink

Dimension: 490 x 440 mm

Built-in hole:

inset: 470 x 420 mm

undermount: 450 x 400 mm - R25

flushmount: 478 x 428 mm - R25

FINISH	CODE
Satin	LIW450SACMU



Accessories see page 204:

06 09 17 32 33 54

Sink kit:

waste drainers 3^{1/2}, space saving-siphon and hooks.

Packaging type:

C: carton packaging

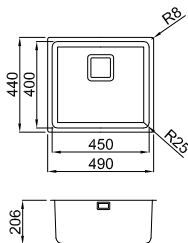

W-Square 400

one-bowl sink

Dimension: 440 x 440 mm

Built-in hole:

inset: 420 x 420 mm

undermount: 400 x 400 mm - R25

flushmount: 428 x 428 mm - R25

FINISH	CODE
Satin	LIW400SACMU

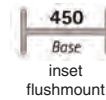

Accessories see page 204:

06 09 17 32 33 54

Sink kit:

waste drainers 3^{1/2}, space saving-siphon and hooks.

Packaging type:

C: carton packaging

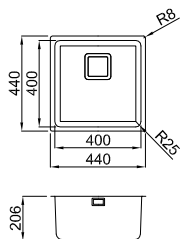



W-Square 340

one-bowl sink

Dimension: 380 x 440 mm

Built-in hole:

inset: 360 x 420 mm

undermount: 340 x 400 mm - R25

flushmount: 368 x 428 mm - R25



Inset



Undermount



Flushmount

FINISH	CODE
Satin	LIW340SACMU

Accessories see page 204:

06 09 17 32 33 54

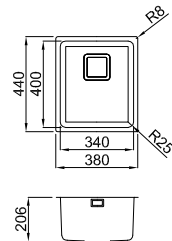

Sink kit:

waste drainers 3^{1/2}, space saving-siphon and hooks.

Packaging type:

C: carton packaging

204
205

Suggested accessories W-Square collection



ATL01001
Wooden chopping board
with insert HPE (178 x 178 mm)

06

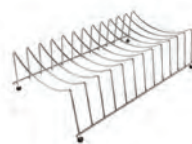

ADI01300
Dish drainer

09



ACI01301
Basket

17



DLA01600
Antiscale

32



DLI01600
Active inox

33



ATQ01300
Squared food waste
disposer flange

54



Stainless Steel
Sinks

SUGGESTED MIXERS



new

STREAM PLUS
code MIKSTPCR



KUBE
code MIKKUBCR



new

BRIDGE
code MIKBRICR

Square Collection

Square 720 2V
two-bowl sink

Square 500
one-bowl sink

Square 340
one-bowl sink

Accessory:
square waste



Simple but precious, these square bowls are the perfect product for whom paying attention to details and design.

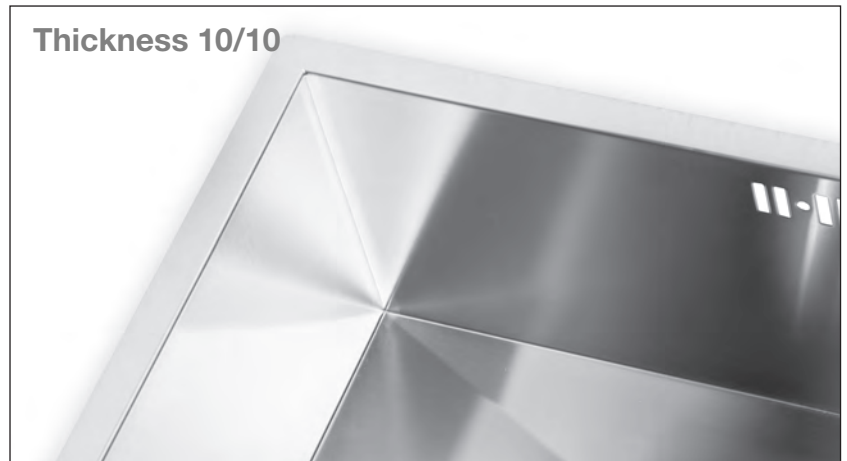

Square Collection: inset and undermounted, stainless steel AISI 304 18/10.



Satin finish: matt but shining, the **satin steel** for years keeps unaltered its elegance values, hygiene and resistance to daily wear and tear.

Production of “authentic” steel sinks.

Our sinks are made of genuine stainless steel **18/10**: ideal ratio between **chrome** and **nickel**.

Chrome makes the steel hard, it stands wear and tear and the nickel increases the impacts resistance.



New accessory: waste cover.



Undermount:

The rim of the sink appears underneath the worktop.



Inset:

The rim of the sink after installation appears on the worktop.



Depth bowl:

210 mm.



Stainless Steel
Sinks



Square 720 2V

two-bowl sink
Dimension: **745 x 440 mm**



Inset



Undermount

FINISH	CODE
--------	------

Inset
Satin LIQ720SAC2V

Buil-in hole: **735 x 430 mm**

Undermount
Satin LIQ720SAC2U

Buil-in hole: **705 x 400 mm**



Accessories see page 211:

06 09 17 32 33 142 146

Sink kit:

waste drainers 3¹/₂, space saving-siphon and hooks.

Packaging type:

C: carton packaging

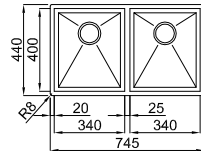

208
209



Square 500

one-bowl sink
Dimension: **540 x 440 mm**



Inset



Undermount

FINISH	CODE
--------	------

Inset
Satin LIQ500SAC

Buil-in hole: **530 x 430 mm**

Undermount
Satin LIQ500SACUN

Buil-in hole: **500 x 400 mm**



Accessories see page 211:

06 09 17 32 33 142 146

Sink kit:

waste drainers 3¹/₂, space saving-siphon and hooks.

Packaging type:

C: carton packaging

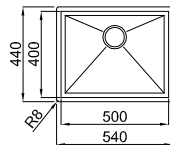

Square 340

one-bowl sink

Dimension: 380 x 440 mm

FINISH	CODE
Inset	
Satin	LIQ340SAC

Buil-in hole: 370 x 430 mm

Undermount

Satin LIQ340SACUN

Buil-in hole: 340 x 400 mm



Accessories see page 211:

06 09 17 32 33 142 146

Sink kit:

waste drainers 3¹/₂, space saving-siphon and hooks.

Packaging type:

C: carton packaging

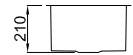
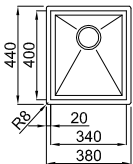



210
211

Suggested accessories **Square** collection



ATL01001
Wooden chopping board
with insert HPE (178 x 178 mm)

06



ADI01300
Dish drainer

09



ACI01301
Basket

17

A richer and studied accessories outfit features our sink proposals.

For each of our model a accessories series is provided for enriching the aesthetics and functionality of our sinks.

We studied integrated systems of accessories, which exploit each of your movement.



DLA01600
Antiscale

32



DLI01600
Active inox

33



ANP13000
Waste accessory
kit 1 way - 3,5"
manual square strainer plug

142

new



ACPM1000
Manual waste
cover

146



SUGGESTED MIXERS



BRIDGE
code MIKBRICR

new



KUBE
code MIKKUBCR



CHEF
code MIKCHECR

Square R14 Collection

Square 720 2V R14
two-bowl sink

Square 720 R14
one-bowl sink

Square 500 R14
one-bowl sink

Square 340 R14
one-bowl sink

Accessory:
square waste



An elegant line equipped by radius and corners for an easier cleaning. Ray 14 corners avoid the dirty depositing: **GUARANTEED HYGIENE.**

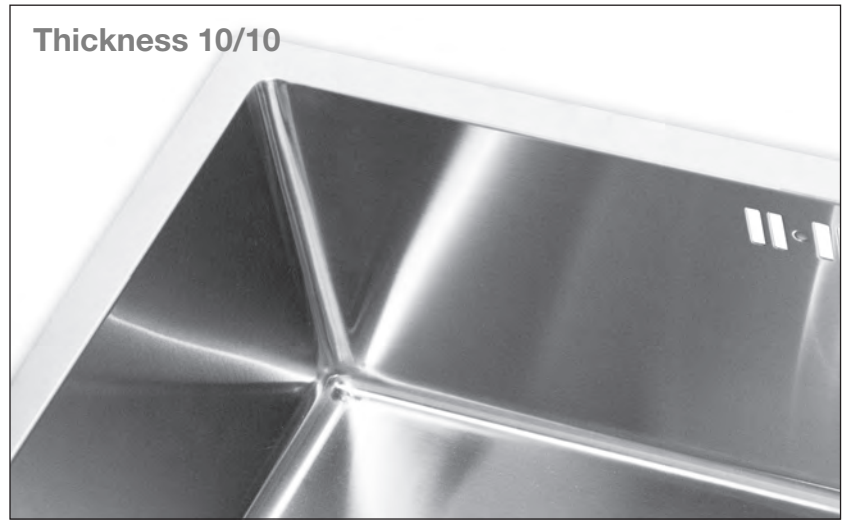

R14 Square Collection: inset and undermounted, stainless steel AISI 304 18/10.



Satin finish: matt but shining, the **satin steel** for years keeps unaltered its elegance values, hygiene and resistance to daily wear and tear.

Production of “authentic” steel sinks.

Our sinks are made of genuine stainless steel **18/10**: ideal ratio between **chrome** and **nickel**.

Chrome makes the steel hard, it stands wear and tear and the nickel increases the impacts resistance.



New accessory: waste cover.



Undermount:

The rim of the sink appears underneath the worktop.



Inset:

The rim of the sink after installation appears on the worktop.



Depth bowl:

210 mm.



Stainless Steel
Sinks



Square 720 2V R14

two-bowl sink

Dimension: **745 x 440 mm - R14**



Inset

FINISH	CODE
Inset	
Satin	LIQ720SAC2V14

Built-in hole: **735 x 430 mm**



Undermount

Undermount

Satin LIQ720SAC2U14

Built-in hole: **705 x 400 mm**



Accessories see page 217:

06 09 17 32 33 142 146

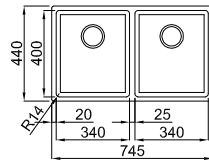

Sink kit:

waste drainers 3¹/₂, space saving-siphon and hooks.

Packaging type:

C: carton packaging

214
215



undermount

Square 720 R14

one-bowl sink

Dimension: **780 x 440 mm - R14**



inset

FINISH	CODE
Inset	
Satin	LIQ720SAC14

Built-in hole: **770 x 430 mm**



Inset

Undermount

Satin LIQ720SACUN14

Built-in hole: **740 x 400 mm**



Undermount



Accessories see page 217:

06 09 17 32 33 142 146

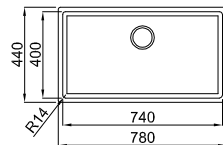

Sink kit:

waste drainers 3¹/₂, space saving-siphon and hooks.

Packaging type:

C: carton packaging

Square 500 R14

one-bowl sink

Dimension: 540 x 440 mm - R14

FINISH	CODE
Inset	
Satin	LIQ500SAC14

Buil-in hole: 530 x 430 mm

Undermount

Satin	LIQ500SACUN14
-------	---------------

Buil-in hole: 500 x 400 mm

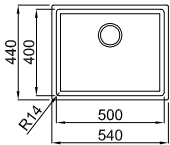

Accessories see page 217:

06 09 17 32 33 142 146

Sink kit:

waste drainers 3^{1/2}, space saving-siphon and hooks.

Packaging type:

C: carton packaging

Square 340 R14

one-bowl sink

Dimension: 380 x 440 mm - R14

FINISH	CODE
Inset	
Satin	LIQ340SAC14

Buil-in hole: 370 x 430 mm

Undermount

Satin	LIQ340SACUN14
-------	---------------

Buil-in hole: 340 x 400 mm

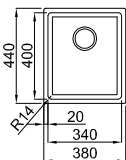

Accessories see page 217:

06 09 17 32 33 142 146

Sink kit:

waste drainers 3^{1/2}, space saving-siphon and hooks.

Packaging type:

C: carton packaging

216
217



Suggested accessories **Square R14** collection



ATL01001
Wooden chopping board
with insert HPE (178 x 178 mm)

06



ADI01300
Dish drainer

09



ACI01301
Basket

17

A richer and studied accessories outfit features our sink proposals.

For each of our model a accessories series is provided for enriching the aesthetics and functionality of our sinks.

We studied integrated systems of accessories, which exploit each of your movement.



DLA01600
Antiscale

32



DLI01600
Active inox

33



ANP13000
Waste accessory
kit 1 way - 3,5"
manual square strainer plug

142

new



ACPM1000
Manual waste
cover

146



SUGGESTED MIXERS



JUST PLUS
code MIKJUPCR

new



TITAN
code MIKTITCR

new



RENO PLUS
code MIKREPCR

new

Space R15 Collection

Space 500 R15
one-bowl sink

Space 450 R15
one-bowl sink

Space 400 R15
one-bowl sink

Space 340 R15
one-bowl sink

Accessory:
square waste



Moulded square bowls equipped by 15 mm ray.
Elegant and functional.



R15 Space Collection: undermounted, stainless steel AISI 304 18/10.



Satin finish: matt but shining, the **satin steel** for years keeps unaltered its elegance values, hygiene and resistance to daily wear and tear.

Production of "authentic" steel sinks.

Our sinks are made of genuine stainless steel **18/10**: ideal ratio between **chrome** and **nickel**.

Chrome makes the steel hard, it stands wear and tear and the nickel increases the impacts resistance.

218
219



New accessory: waste cover.



Undermount:

The rim of the sink appears underneath the woktop.



Depth bowl:

210 mm.



Stainless Steel
Sinks



Space 500 R15

one-bowl sink **sottotop**
 Dimension: **540 x 440 mm - R15**
 Built-in hole: **501 x 401 mm**



FINISH	CODE
Satin	LIC500SACUN15

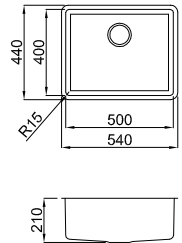

Accessories see page 221:

06 09 17 32 33 142 146

Sink kit:

waste drainers 3^{1/2}, space saving-siphon and hooks.

Packaging type:

C: carton packaging



Space 450 R15

one-bowl sink **sottotop**
 Dimension: **490 x 440 mm - R15**
 Built-in hole: **451 x 401 mm**



FINISH	CODE
Satin	LIC450SACUN15

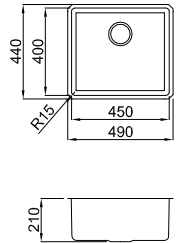

Accessories see page 221:

06 09 17 32 33 142 146

Sink kit:

waste drainers 3^{1/2}, space saving-siphon and hooks.

Packaging type:

C: carton packaging

220
221



Space 400 R15

one-bowl sink **sottotop**
 Dimension: **440 x 440 mm - R15**
 Built-in hole: **401 x 401 mm**



FINISH	CODE
Satin	LIC400SACUN15

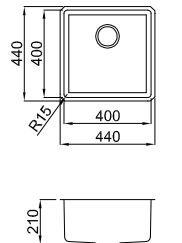

Accessories see page 221:

06 09 17 32 33 142 146

Sink kit:

waste drainers 3^{1/2}, space saving-siphon and hooks.

Packaging type:

C: carton packaging



Space 340 R15

one-bowl sink **sottotop**
 Dimension: **380 x 440 mm - R15**
 Built-in hole: **341 x 401 mm**



FINISH	CODE
Satin	LIC340SACUN15

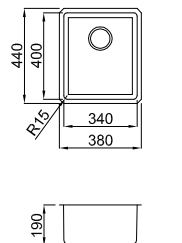

Accessories see page 221:

06 09 17 32 33 142 146

Sink kit:

waste drainers 3^{1/2}, space saving-siphon and hooks.

Packaging type:

C: carton packaging

Suggested accessories **Space R15** collection



ATL01001
Wooden chopping board
with insert HPE (178 x 178 mm)

06

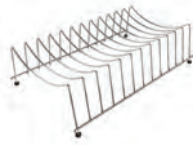

ADI01300
Dish drainer

09



ACI01301
Basket

17

A richer and studied accessories outfit features our sink proposals.

For each of our model a accessories series is provided for enriching the aesthetics and functionality of our sinks.

We studied integrated systems of accessories, which exploit each of your movement.



DLA01600
Antiscale

32



DLI01600
Active inox

33



ANP13000
Waste accessory
kit 1 way - 3,5"
manual square strainer plug

142

new



ACPM1000
Manual waste
cover

146



SUGGESTED MIXERS



STREAM PLUS
code MIKSTPCR

new



DOVE PLUS
code MIKDOPCR

new



DIONISIO
code MIKDNSCR

Space R50 Collection

Single rectangular bowls, versatile and practical for a better functionality in the kitchen.

Accessory:
square waste



Space 500 R50
one-bowl sink

Space 455 R50
one-bowl sink

Space 450 R50
one-bowl sink

Space 405 R50
one-bowl sink

Space 400 R50
one-bowl sink

Space 340 R50
one-bowl sink

Space 290 R50
one-bowl sink

Space 130 R50
one-bowl sink

Thickness 10/10



Space R50 Collection: undermounted, stainless steel AISI 304 18/10.



Satin finish: matt but shining, the **satin steel** for years keeps unaltered its elegance values, hygiene and resistance to daily wear and tear.

Production of "authentic" steel sinks.

Our sinks are made of genuine stainless steel **18/10**: ideal ratio between **chrome** and **nickel**.

Chrome makes the steel hard, it stands wear and tear and the nickel increases the impacts resistance.

222
223



New accessory: waste cover.



Undermount:

The rim of the sink appears underneath the woktop.



Depth bowl:

160 - 210 mm.



Stainless Steel
Sinks



Space 500 R50

one-bowl sink **sottotop**
 Dimension: **540 x 440 mm - R50**
 Built-in hole: **504 x 401 mm - R60**



FINISH	CODE
Satin	LIC500SACUN

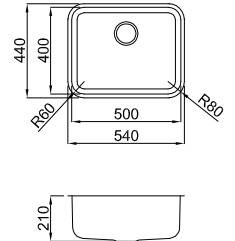

Accessories see page 227:

06 09 17 32 33 142 146

Sink kit:

waste drainers 3^{1/2}, space saving-siphon and hooks.

Packaging type:

C: carton packaging



Space 455 R50

one-bowl sink **sottotop**
 Dimension: **490 x 490 mm - R50**
 Built-in hole: **451 x 451 mm - R60**



FINISH	CODE
Satin	LIC455SACUN

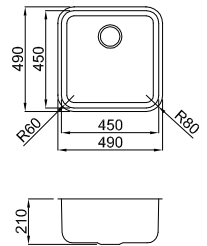

Accessories see page 227:

03 06 09 17 32 33 142 146

Sink kit:

waste drainers 3^{1/2}, space saving-siphon and hooks.

Packaging type:

C: carton packaging



Space 450 R50

one-bowl sink **sottotop**
 Dimension: **490 x 440 mm - R50**
 Built-in hole: **451 x 401 mm - R60**



FINISH	CODE
Satin	LIC450SACUN

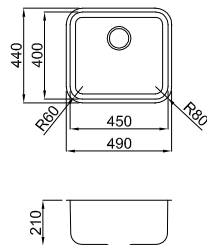

Accessories see page 227:

06 09 17 32 33 142 146

Sink kit:

waste drainers 3^{1/2}, space saving-siphon and hooks.

Packaging type:

C: carton packaging



Space 405 R50

one-bowl sink **sottotop**
 Dimension: **440 x 490 mm - R50**
 Built-in hole: **401 x 451 mm - R60**



FINISH	CODE
Satin	LIC405SACUN

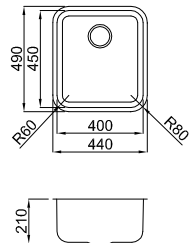

Accessories see page 227:

03 06 09 17 32 33 142 146

Sink kit:

waste drainers 3^{1/2}, space saving-siphon and hooks.

Packaging type:

C: carton packaging

Space 400 R50

one-bowl sink **sottotop**
 Dimension: 440 x 440 mm - R50
 Built-in hole: 401 x 401 mm - R60

FINISH	CODE
Satin	LIC400SACUN

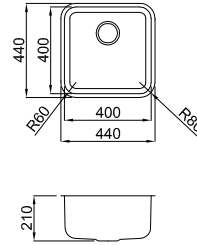

Accessories see page 227:

06 09 17 32 33 142 146

Sink kit:
 waste drainers 3^{1/2}, space saving-siphon and hooks.

Packaging type:
C: carton packaging

Space 340 R50

one-bowl sink **sottotop**
 Dimension: 380 x 440 mm - R50
 Built-in hole: 341 x 401 mm - R60

FINISH	CODE
Satin	LIC340SACUN

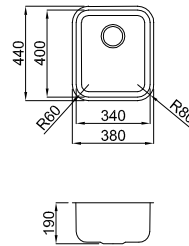

Accessories see page 227:

06 09 17 32 33 142 146

Sink kit:
 waste drainers 3^{1/2}, space saving-siphon and hooks.

Packaging type:
C: carton packaging

Space 290 R50

one-bowl sink **sottotop**
 Dimension: 330 x 440 mm - R50
 Built-in hole: 289 x 399 mm - R60

FINISH	CODE
Satin	LIC290SACUN

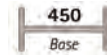
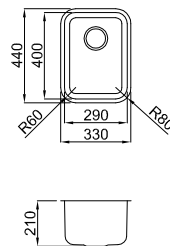

Accessories see page 227:

09 32 33 142 146

Sink kit:
 waste drainers 3^{1/2}, space saving-siphon and hooks.

Packaging type:
C: carton packaging

Space 130 R50

one-bowl sink **sottotop**
 Dimension: 175 x 325 mm - R50
 Built-in hole: 149 x 299 mm - R60

FINISH	CODE
Satin	LIC130SACUN

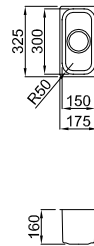

Accessories see page 227:

09 32 33 142 146

Sink kit:
 waste drainers 3^{1/2}, space saving-siphon and hooks.

Packaging type:
C: carton packaging



226
227

Suggested accessories **Space R50** collection

A richer and studied accessories outfit features our sink proposals.

For each of our model a accessories series is provided for enriching the aesthetics and functionality of our sinks.

We studied integrated systems of accessories, which exploit each of your movement.



AVP02001
Polycarbonate bowl

03



ATL01001
Wooden chopping board with insert HPE (178 x 178 mm)

06

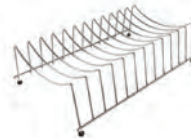

ADI01300
Dish drainer

09



ACI01301
Basket

17



DLA01600
Antiscale

32



DLI01600
Active inox

33



ANP13000
Waste accessory kit 1 way - 3,5" manual square strainer plug

142

new



ACPM1000
Manual waste cover

146



SUGGESTED MIXERS



JUST PLUS
code MIKJUPCR

new



STREAM PLUS
code MIKSTPCR

new



RENO PLUS
code MIKREPCR

new

Special Collection

Single or double bowls with or without draining area: quality enters into the kitchen.

Special ESA 920
one and half bowl sink with draining area

Special ESA 770
one and half bowl sink with draining area

Special ROUND 830
one-bowl sink with draining area

Special ROUND 770
one-bowl sink with draining area

Special 350
two-bowl sink

Special 300
one-bowl sink with draining area

Special 250
one and half bowl sink

Special 250 UNDERMOUNT
one and half bowl sink

Special 135
one-bowl sink with draining area

Special 125
one-bowl sink with draining area

Special 100
one-bowl sink



Thickness 6/10

Special Collection: builtin, stainless steel AISI 304 18/10.



Satin finish: matt but shining, the **satin steel** for years keeps unaltered its elegance values, hygiene and resistance to daily wear and tear.

Production of "authentic" steel sinks.

Our sinks are made of genuine stainless steel **18/10**: ideal ratio between **chrome** and **nickel**.

Chrome makes the steel hard, it stands wear and tear and the nickel increases the impacts resistance.

228
229



New accessory: waste cover.



Undermount:

The rim of the sink appears underneath the woktop.



Inset:

The rim of the sink after installation appears on the woktop.



Depth bowl:

125 - 195 mm.

Special ESA 920

one and half bowl sink with draining area

Dimension: 920 x 500 mm
Thickness: 8/10

FINISH	CODE
Satin	LIX920SACEX
Satin	LIX920SASEX

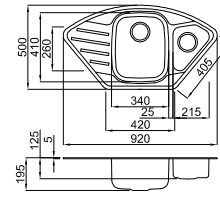

equipped with mixer hole

Built-in hole:

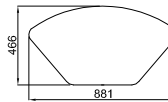

Accessories see page 231:

09 32 33 60 61 146

Sink kit:

waste drainers 3¹/₂,
space saving-siphon and hooks.

Packaging type:

C: carton packaging
S: bag packaging

Special ESA 770

one and half bowl sink with draining area

Dimension: 770 x 500 mm
Thickness: 8/10

FINISH	CODE
Satin	LIX770SACEX
Satin	LIX770SASEX

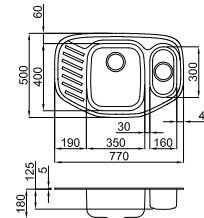

*When it starts the composition



equipped with mixer hole

Built-in hole:

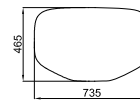

Accessories see page 231:

09 32 33 146

Sink kit:

waste drainers 3¹/₂,
space saving-siphon and hooks.

Packaging type:

C: carton packaging
S: bag packaging

Special ROUND 830

one-bowl sink with draining area

Dimension: 830 x 435 mm
Thickness: 6/10

FINISH	CODE
Satin	LIX830SACRD
Satin	LIX830SASRD
Satin	LIX830SACRS
Satin	LIX830SASRS

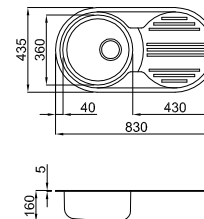

equipped with mixer hole

Built-in hole:

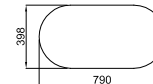

Accessories see page 231:

09 16 32 33 146

Sink kit:

waste drainers 3¹/₂,
space saving-siphon and hooks.

Packaging type:

C: carton packaging
S: bag packaging
RD: right bowl
RS: left bowl

Special ROUND 770

one-bowl sink with draining area

Dimension: 770 x 480 mm
Thickness: 6/10

FINISH	CODE
Satin	LIX770SACRD
Satin	LIX770SASRD
Satin	LIX770SACRS
Satin	LIX770SASRS

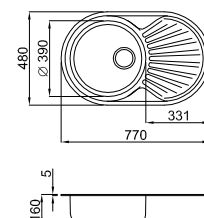

equipped with mixer hole

Built-in hole:

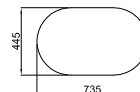

Accessories see page 231:

08 09 32 33 146

Sink kit:

waste drainers 3¹/₂,
space saving-siphon and hooks.

Packaging type:

C: carton packaging
S: bag packaging
RD: right bowl
RS: left bowl



*When it starts the composition



Special 350

two-bowl sink

Dimension: **780 x 435 mm**
Built-in hole: **760 x 415 mm**
Thickness: **6/10**

FINISH	CODE
Satin	LIX350SAC2V
Satin	LIX350SAS2V

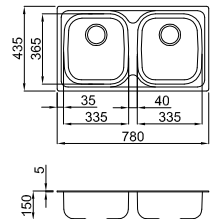

equipped with mixer hole

Accessories see page 231:

09 32 33 146

Sink kit:

waste drainers 3^{1/2},
space saving-siphon and hooks.

Packaging type:

C: carton packaging
S: bag packaging



Special 300

one-bowl sink with draining area

Dimension: **780 x 435 mm**
Built-in hole: **760 x 415 mm**
Thickness: **6/10**

FINISH	CODE
Satin	LIX300SACDX
Satin	LIX300SASDX
Satin	LIX300SACSX
Satin	LIX300SASSX

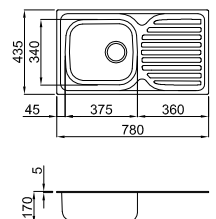

equipped with mixer hole

Accessories see page 231:

09 32 33 146

Sink kit:

waste drainers 3^{1/2},
space saving-siphon and hooks.

Packaging type:

C: carton packaging
S: bag packaging
DX: right bowl
SX: left bowl

230
231



*When it starts the composition



Special 250

one and half bowl sink

Dimension: **620 x 490 mm**
Built-in hole: **600 x 470 mm**
Thickness: **8/10**

FINISH	CODE
Satin	LIX250SAC
Satin	LIX250SAS

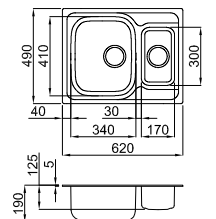

equipped with mixer hole

Accessories see page 231:

09 17 32 33 61 146

Sink kit:

waste drainers 3^{1/2},
space saving-siphon and hooks.

Packaging type:

C: carton packaging
S: bag packaging



Special 250 SOTTOTOP

one and half bowl sink

Dimension: **575 x 470 mm**
Thickness: **8/10**

FINISH	CODE
Satin	LIX250SACRDUN
Satin	LIX250SASRDUN
Satin	LIX250SACRSUN
Satin	LIX250SASRSUN

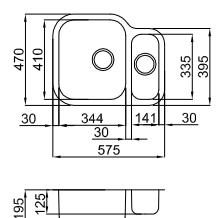

equipped with mixer hole

Accessories see page 231:

09 32 33 61 146

Sink kit:

waste drainers 3^{1/2},
space saving-siphon and hooks.

Packaging type:

C: carton packaging
S: bag packaging
RD: right bowl
RS: left bowl

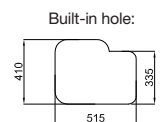

Special 135

one-bowl sink with draining area

Dimension: **650 x 500** mm
Built-in hole: **630 x 480** mm
Thickness: **6/10**

FINISH	CODE
Satin	LIX135SACDX
Satin	LIX135SASDX
Satin	LIX135SACSX
Satin	LIX135SASSX

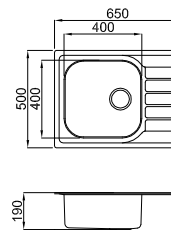

equipped with mixer hole

Accessories see page 231:

09 32 33 146

Sink kit:
waste drainers 3^{1/2},
space saving-siphon and hooks.

Packaging type:
C: carton packaging
S: bag packaging
DX: right bowl
SX: left bowl

Special 125

one-bowl sink with draining area

Dimension: **580 x 500** mm
Built-in hole: **560 x 480** mm
Thickness: **6/10**

FINISH	CODE
Satin	LIX125SACDX
Satin	LIX125SASDX
Satin	LIX125SACSX
Satin	LIX125SASSX

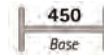
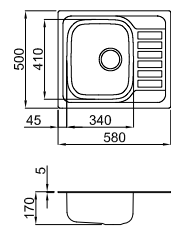

equipped with mixer hole

Accessories see page 231:

09 17 32 33 64 146

Sink kit:
waste drainers 3^{1/2},
space saving-siphon and hooks.

Packaging type:
C: carton packaging
S: bag packaging
DX: right bowl
SX: left bowl

Special 100

one-bowl sink

Dimension: **480 x 480** mm
Built-in hole: **460 x 460** mm
Thickness: **6/10**

FINISH	CODE
Satin	LIX100SAC
Satin	LIX100SAS

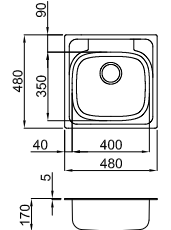

*When it starts the composition



equipped with mixer hole

Accessories see page 231:

09 32 33 61 146

Sink kit:
waste drainers 3^{1/2},
space saving-siphon and hooks.

Packaging type:
C: carton packaging
S: bag packaging

Suggested accessories **Special** collection



ADI01300
Dish drainer

09



DLA01600
Antiscale

32



DLI01600
Active inox

33

146



ACPM1000
Manual waste cover

146

elleci mixers

232
233



MIXERS

COLLECTION

MADEIRA
INDO
INVISIO ELECTRONIC
INVISIO MECHANICAL
FUSION PLUS
FUSION
CHEF
DIONISIO
FLY
TEVERE
ARNO
ARNO LIGHT
GANGE
TIGRI
JUST PLUS
JUST
KUBE
CUPIDO
BLADE
SUNNY
MOONY
ARES

VOLTA
DOVE PLUS
DOVE
STREAM PLUS
STREAM
BRIDGE
TITAN
RENO PLUS
RENO
SAVA
DANUBIO
URANO
ATENA
PO
TESEO
SENN
VENERE
MINERVA
VULCANO
QUEEN
RIO
TAGO
ELBA

Mixers Collections



100% Made in Italy

All Elleci mixers are Made in Italy. Our manufacturing chain guarantees high quality, prestige, reliability, origin and, above all, Italian design.

ELECTRONIC AND MANUAL CONTROL ON EVERY SINGLE PIECE

Quality

Our mixers components control is done by the accuracy of numerical control machines and their assembly is electronically monitored. Before being packaged, our mixers are one by one manually cleaned; this operation allows, both a visual inspection of chroming or painting quality and the general aspect of the piece.

MATERIALS FOR A GUARANTEED TOTAL HYGIENE

Hygiene

All mixers are manufactured of materials in conformity with National and International rules referring them, which get in contact with drinking water, which guarantee a continuing hygiene during the mixer opening/closing, such as like product certifications: **DVGW KTW** Class A in Germany, the Dutch **KIWA**, the English **WRAS**, the Swiss **SVGW**, the French **ACS**, **NSF** in the United States and the Australian **SAI** Global.

10-YEAR USAGE FOR BAKED CLAY CARTIDGES AND DISCS

Saving

Our products come from experience and continuous technological updating, which always are more careful on energetic saving and on ecological demands.

All the mixers, equipped by ceramic disc cartridges, are guaranteed for 70.000 opening/closing, in other words, 10 year use by a four people family. Therefore, they are designed to last in time.

Elleci mixing cartridges meet the requirements of the most important International standards, such as EN, NF, ASME, ASSE, CSTB, AS/NZS 3718. Cartridges are equipped by a double control device for regulating flow and temperature, enabling the consumer to adjust flow and temperature parameters according to his needs in order to save resources and energy.



Features and functions:

- Pull-out showers
- Water filtering
- Material and painting
- Vertical/horizontal adjustment
- Retractability for under-window installation

Wide available choice

ELLECI mixers strong point is the wide range of offered products, extended from different points of view such as types, finishes, materials, colours and prices.



Green

increased attention to ecological aspects.



Professional

functional use of technology.



Design

Made in Italy features.



Classic

tradition and country style.



Suite Vitrotek, Metaltek, Granitek and Stainless Steel combination.

Who loves harmony and wishes keep it in every detail, creating a one and only kitchenplace, our mixers' models offer the widest range of colours to be combined to our sinks, cooking tops, ovens and hoods.



Increased attention to ecological aspects.



Why buying drinking water? Just think of necessary energy needed to produce, disinfect and fill bottles and then to transport and stock them. An energy loss that, drop by drop, affects the final price. Unique solution: **domestic water depuration.**

SAFE RE-USING OF SUPPLIED WATER

Our Green mixers supply warm/cold water like a standard mixer and furthermore they supply drinking water through a separated distribution to guarantee a perfect hygiene.

Healthy and safe drinking water directly from your domestic mixer.

1 Cold water

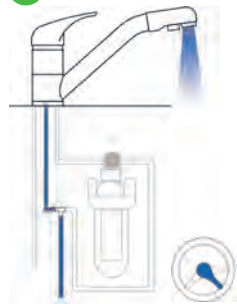

2 Hot water

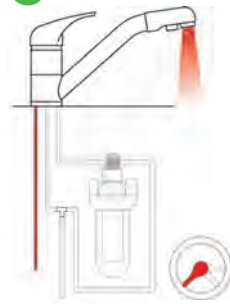

3 Purified water

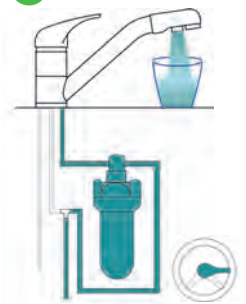

236
237



MORE TASTE

The suggested filtering kit is able to purify drinking water, eliminating impurities, microorganisms, chlorine, unpleasant smells and tastes, reducing polluting substances. The result is a natural water with the same features of its source, with favourable costs and extreme comfort in use and maintenance. Filtering kit is a filter with the same size of a bottle, to be mounted under the sink, coordinated to a multifunction mixer which supplies warm/cold water like a normal faucet and furthermore it supplies drinking water through a separated distribution to guarantee a perfect hygiene.



MORE PROFIT

The exclusive filtering kit, in addition to ensure a soft and delicate taste, it positively affects the economical aspect. Each person drinks, in average from 1,5 up to 2 litres per day. The cost difference is about 1000 times less than a litre bottle of water, saving in this way time, effort and space. The new range has been designed to ensure the highest quality of water at the lowest possible cost, focusing both on the saving and environmental impact.



MORE ECOLOGY

The filtering kit represents the perfect match between functionality and respect for nature. Thanks to it, the packaging of mineral waters is totally eliminated, being a pollution cause due to its high environmental impact. The plastic bottles production and transport require about 22 oil and 108 litres water, besides the carbon dioxide. Through domestic filtering, the plastic materials can be reduced of 53% compared to traditional range, so to further reduce the environmental impact.



ADVANTAGES:

- Family money saving.*
- Simple installation, it does not involve starting-up or fluxing.*
- Lead and nickel reduction.*
- Reduced size and less plastic material usage.*

Madeira

Single lever mixer swivel round spout (Ø 20 mm). Head with two separated distribution valves. Mixer body treated by a **deleading system**. Mixer hole dimensions: Ø 35 mm.

FINISH	CODE
Chrome	MIKMADCR
Granitek	
51 avena	MGKMAD51

Available colours:
(see inside cover pages)



fin. Granitek 51 avena

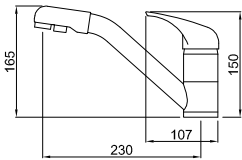

FILTERING KIT



Code AFIO1300



Safe re-using and supplied water.

Madeira and Indo mixers supply warm/cold water as a standard mixer and furthermore they supply drinking water through a separated distribution for guaranteeing a perfect hygiene. **Healthy and safe drinking water directly from your domestic mixer.**

Filter for eliminating chlorine, odours, unpleasant smells and microorganisms present in the water and reducing polluting substances.

Indo

Single lever, one outlet mixer with swivel spout and two separated distribution valves. Mixer body treated by a **deleading system**. Mixer hole dimensions: Ø 35 mm.

FINISH	CODE
Chrome	MIKINDCR

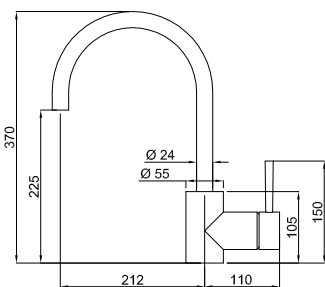

FILTERING KIT



Code AFIO1300



Invisio ELECTRONIC

Retractable electromixer with pull-out shower, equipped by joystick and support base for water supply and temperature adjustment.

Mixer hole dimensions: Ø 48 mm.

Joystick hole dimensions: Ø 15 mm.

Electromixer suitable for under-window installation.

FINISH	CODE
Chrome	EIKINVCR

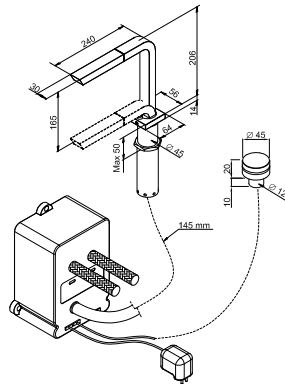

238
239



Invisio MECHANICAL

Retractable mixer with pull-out shower, equipped by joystick, without support base for water supply and temperature adjustment.

Mixer hole dimensions: Ø 48 mm.

Lever hole dimensions: Ø 35 mm.

Mixer suitable for under-window installation.

FINISH	CODE
Chrome	MIKINVCR

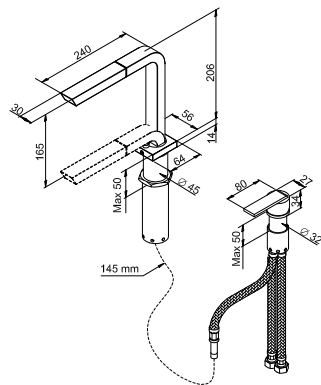

Fusion Plus

Mixer with remote control, retractable, swivel spout, separated pull-out, one-jet shower 360°.
 Connection hoses with 3/8".
 Mixer hole dimensions: Ø 35 mm.
 Lever and Shower hole dimensions: Ø 55 mm.
 Mixer suitable for under-window installation.

FINISH	CODE
Chrome	MIKFUPCR

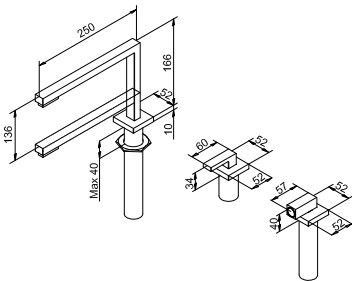

Fusion

Mixer with remote control. 360° swivel spout.
 Connection hoses with 3/8".
 Mixer hole dimensions: Ø 35 mm.
 Lever hole dimensions: Ø 55 mm.
 Mixer suitable for under-window installation.

FINISH	CODE
Chrome	MIKFUSCR

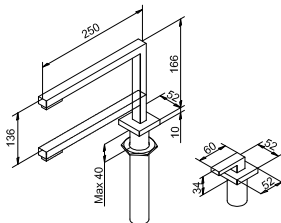



Shower

Chef

Lever Mixer with joystick, high, swivel spout and pull-out shower.
Mixer hole dimensions: Ø 35 mm.

FINISH	CODE
Chrome	MIKCHECR

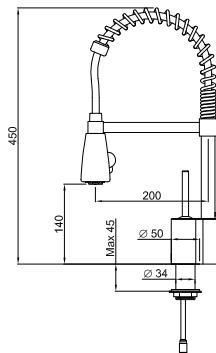

240
241



Shower

Dionisio

Lever mixer with high, swivel spout and pull-out shower.
Mixer hole dimensions: Ø 35 mm.

FINISH	CODE
Chrome	MIKDNSCR

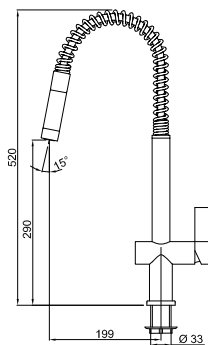

Fly

Lever Mixer with high, swivel spout.
Equipped by an innovative 360° swivel supply outlet, allowing the water jet to reach every sink corner.
Mixer hole dimensions: Ø 35 mm.

FINISH	CODE
Chrome	MIKFLYCR
Chrome&White	MVKFLY96
Chrome&Black	MVKFLY86

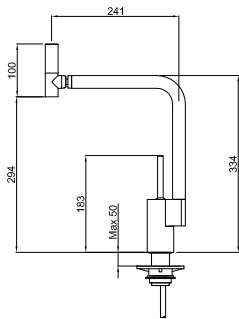

Knob and handle supply outlet in anodized aluminium, available in colour finishes: black, white and chrome.

Tevere

Retractable mixer, with pull-out shower and separated lever.
Mixer hole dimensions: Ø 35 mm.
Mixer suitable for under-window installation.

FINISH	CODE
Chrome	MIKTEVCR
Brushed	MIKTEVSP

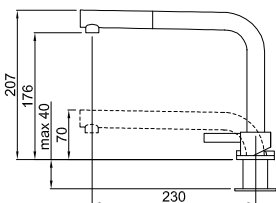



Arno

Lever Mixer with high, swivel spout and pull-out shower.
Mixer hole dimensions: Ø 35 mm.

Available colours:
(see inside cover pages)

FINISH	CODE
Chrome	MIKARNCR
Brushed*	MIKARNSP
Vitrotek	
96 white	MVKARN96
Metaltek	
73 titanium*	MMKARN73



chrome finish

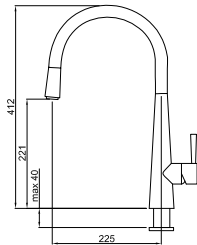

Metaltek 73 titanium finish

* until stock lasts

242
243



Arno Light

NEW

Lever mixer with high, swivel spout and pull-out shower.
White-coloured led.
Mixer hole dimensions: Ø 35 mm.

Available colours:
(see inside cover pages)

FINISH	CODE
Chrome	MIKARLCR
Vitrotek	
96 white	MVKARL96



Vitrotek 96 white finish

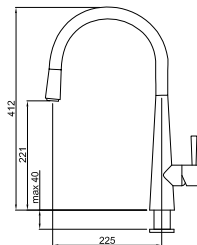



Lighting water flow

Arno Light mixer is characterized of a technology that gives lighting to the flow without using electricity, since the system is self-powered.



Gange

Lever mixer with high, square, swivel spout.
Mixer hole dimensions: Ø 35 mm.

Available colours:
(see inside cover pages)

Metaltek finish:

79 aluminium - 77 chromium u.s.l.
73 titanium - 71 alluminio u.s.l.
70 ghisa u.s.l.

Granitek finish:

59 antracite u.s.l.
52 bianco - 51 avena

To complete your order add
the colour number chosen
at the end of the code.

* (u.s.l.) until stock lasts

FINISH	CODE
Chrome	MIKGANCR
Metaltek	MMKGAN
Granitek	MGKGAN

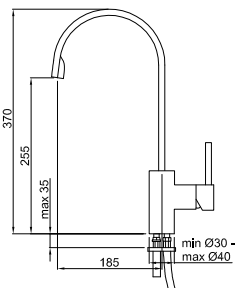

Metaltek 79 aluminium finish



chrome finish



Metaltek 73 titanium finish



Granitek 51 avena finish

244
245

Tigri

Lever mixer with swivel spout.
Mixer hole dimensions: Ø 35 mm.

Available colours:
(see inside cover pages)

Vitrotek finish:

96 white - 86/40 black

Metaltek finish:

79 aluminium - 73 titanium
72 rame u.s.l. - 71 alluminio u.s.l.
70 ghisa f.e.s.

Granitek finish:

76 hamada u.s.l. - 62 bianco antico
61 pietra antica u.s.l.
59 antracite - 58 grigio ambra u.s.l.
57 pietra vecchia u.s.l.
54 nero u.s.l. - 53 terra u.s.l.
52 bianco - 51 avena

To complete your order add
the colour number chosen
at the end of the code.

* (u.s.l.) until stock lasts

FINISH	CODE
Chrome	MIKTIGCR
Vitrotek	MVKTIG
Metaltek	MMKTIG
Granitek	MGKTIG

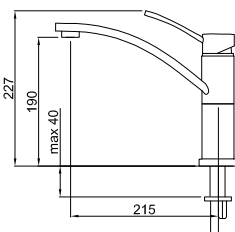

chrome finish



Vitrotek 86/40 black finish



Vitrotek 96 white finish



Metaltek 72 rame finish

elleci mixers

Just Plus

Lever mixer with high, swivel spout and pull-out shower.
Mixer hole dimensions: Ø 35 mm.



FINISH	CODE
Chrome	MIKJUPCR
Vitrotek	
96 white	MVKJUP96



chrome finish

Available colours:
(see inside cover pages)

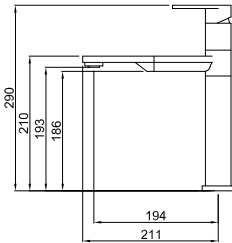

Vitrotek **96 white** finish

Just

Lever mixer with swivel spout.
Mixer hole dimensions: Ø 35 mm.

FINISH	CODE
Chrome	MIKJUSCR
Vitrotek	
96 white	MVKJUS96
86 black	MVKJUS86



fin. Vitrotek **96 white**

Available colours:
(see inside cover pages)

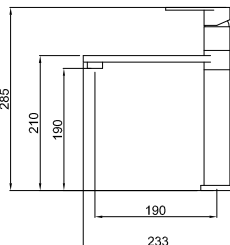

Vitrotek **86/40 black** finish



chrome finish

Kube

Lever mixer with swivel spout.
Mixer hole dimensions: Ø 35 mm.

Available colours:
(see inside cover pages)

FINISH	CODE
Chrome	MIKKUBCR
Vitrotek	
96 white	MVKKUB96
86 black	MVKKUB86

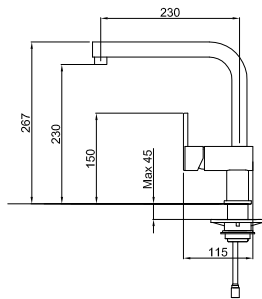

chrome finish



Vitrotek 86/40 black finish



Vitrotek 96 white finish

246
247

Cupido

Lever Mixer with inclined, swivel spout.
Mixer hole dimensions: Ø 35 mm.

FINISH	CODE
Chrome	MIKCUPCR

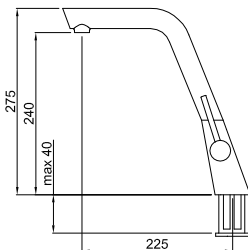

chrome finish



248
249



Blade

Lever mixer with inclined, swivel spout. new
 Mixer hole dimensions: Ø 35 mm.

FINISH	CODE
Chrome	MIKBLACR
Vitrotek	
96 white	MVKBLA96
86 black	MVKBLA86
Metaltek	
79 aluminium	MMKBLA79
Granitek	
43 tortora new	MGKBLA43

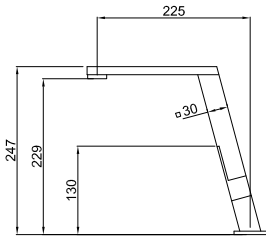

chrome finish

Available colours:
 (see inside cover pages)



Metaltek 79 aluminium finish



Vitrotek 86/40 black finish



Granitek 43 tortora (new)





Sunny

Mixer with swivel spout and pull-out shower.
Mixer hole dimensions: Ø 35 mm.

Available colours:
(see inside cover pages)

Vitrotek finish:

* 96 white u.s.l. - 86/40 black u.s.l.

Metaltek finish:

* 79 aluminium u.s.l. - 73 titanium u.s.l.
* 71 alluminio u.s.l. - 70 ghisa u.s.l.

FINISH	CODE	
Chrome	MIKSUNCR	u.s.l.
Brushed	MIKSUNSP	u.s.l.
Vitrotek	MVKSUN	
Metaltek	MMKSUN	

To complete your order add the colour number chosen at the end of the code.

* (u.s.l.) until stock lasts

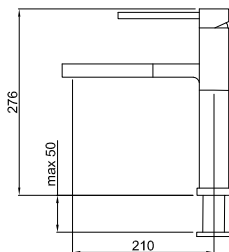

Vitrotek 96 white finish



chrome finish



Vitrotek 86/40 black finish



Metaltek 79 aluminium finish

250
251

Moony

Lever mixer with swivel spout.
Mixer hole dimensions: Ø 35 mm.

Available colours:
(see inside cover pages)

Vitrotek finish:

* 96 white u.s.l. - 86/40 black u.s.l.

Metaltek finish:

* 79 aluminium u.s.l. - 73 titanium u.s.l.
* 71 alluminio u.s.l. - 70 ghisa u.s.l.

FINISH	CODE	
Chrome	MIKMOOCR	u.s.l.
Brushed	MIKMOOSP	u.s.l.
Vitrotek	MVKMOO	
Metaltek	MMKMOO	

To complete your order add the colour number chosen at the end of the code.

* (u.s.l.) until stock lasts

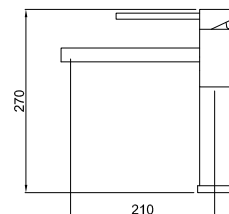

Metaltek 73 titanium finish



chrome finish



Vitrotek 86/40 black finish



Vitrotek 96 white finish

elleci mixers

Ares

Lever mixer with swivel spout.
Mixer hole dimensions: Ø 35 mm.

FINISH	CODE
Chrome	MIKARECR
Vitrotek	MVKARE
Metaltek	MMKARE
Granitek	MGKARE

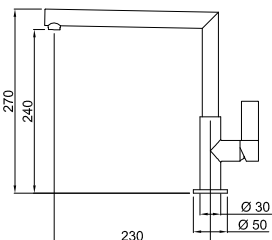

Metaltek 73 titanium finish



Vitrotek 90 chocolate finish



fin. Granitek 43 tortora (new)



Metaltek 79 aluminium finish

Available colours:
(see inside cover pages)

Vitrotek finish:
96 white - *94 ice u.s.l.
90 chocolate - 86/40 black

Metaltek finish:
79 aluminium - 73 titanium
43 tortora (new)

To complete your order add the colour number chosen at the end of the code.

* (u.s.l.) until stock lasts

Volta

Lever mixer with high, swivel spout.
Mixer hole dimensions: Ø 35 mm.

FINISH	CODE
Chrome	MIKVTACR
Vitrotek	MVKVTA
Metaltek	MMKVTA
Granitek	MGKVTA

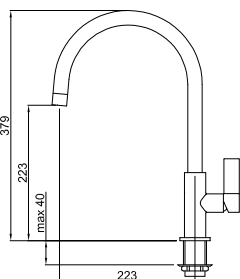

Vitrotek 86/40 black finish



Vitrotek 90 chocolate finish



Metaltek 79 aluminium finish



Metaltek 73 titanium finish

Available colours:
(see inside cover pages)

Vitrotek finish:
96 white - 90 chocolate
86/40 black

Metaltek finish:
79 aluminium - 73 titanium

Granitek finish:
62 bianco antico (new)
51 avena (new)

To complete your order add the colour number chosen at the end of the code.



Shower

Dove Plus

new

Lever mixer with high, swivel spout and pull-out shower.
Mixer hole dimensions: Ø 35 mm.

Available colours:
(see inside cover pages)

Vitrotek finish:
96 white - 86/40 black

Metaltek finish:
79 aluminium - 73 titanium

FINISH	CODE
Chrome	MIKDOPCR
Vitrotek	MVKDOP
Metaltek	MMKDOP

To complete your order add the colour number chosen at the end of the code.

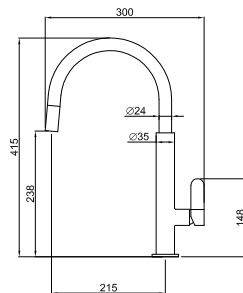

Metaltek 73 titanium finish



Vitrotek 96 white finish



Vitrotek 86/40 black finish



Metaltek 79 aluminium finish

252
253

Dove

new

Lever mixer with high, swivel spout.
Mixer hole dimensions: Ø 35 mm.

Available colours:
(see inside cover pages)

Vitrotek finish:
96 white - 86/40 black

Metaltek finish:
79 aluminium - 73 titanium

Granitek finish:
43 tortora

FINISH	CODE
Chrome	MIKDOVCR
Vitrotek	MVKDOV
Metaltek	MMKDOV
Granitek	MGKDOV

To complete your order add the colour number chosen at the end of the code.

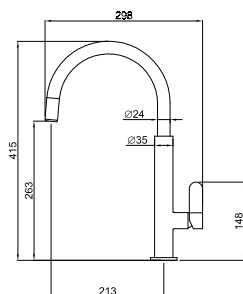

Granitek 43 tortora finish



chrome finish



Vitrotek 86/40 black finish



Metaltek 79 aluminium finish



254
255



Stream Plus



Lever mixer with high, swivel spout and pull-out shower.
Mixer hole dimensions: Ø 35 mm.



Available colours:
(see inside cover pages)

FINISH	CODE
Chrome	MIKSTPCR
Vitrotek	
96 white	MVKSTP96
86 black	MVKSTP86
Metaltek	
79 aluminium	MMKSTP79



chrome finish

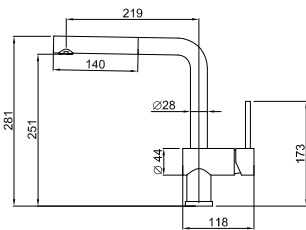

Vitrotek 96 white finish

Vitrotek 86/40 black finish

Metaltek 79 aluminium finish

Stream



Lever mixer with swivel spout.
Mixer hole dimensions: Ø 35 mm.

Available colours:
(see inside cover pages)

FINISH	CODE
Chrome	MIKSTRCR
Vitrotek	
96 white	MVKSTR96
86 black	MVKSTR86
Metaltek	
79 aluminium	MMKSTR79



chrome finish

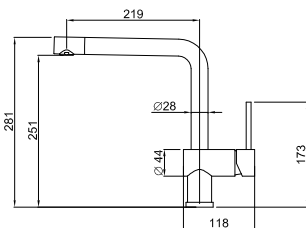

Vitrotek 96 white finish

Vitrotek 86/40 black finish

Metaltek 79 aluminium finish

Bridge

Lever mixer with swivel spout.
Mixer hole dimensions: Ø 35 mm.



Available colours:
(see inside cover pages)

- Vitrotek finish:**
96 white - 86/40 black
- Metaltek finish:**
79 aluminium - 73 titanium
- Granitek finish:**
68 bianco titano
62 bianco antico - 51 avena

FINISH	CODE
Chrome	MIKBRICR
Vitrotek	MVKBRI
Metaltek	MMKBRI
Granitek	MGKBRI

To complete your order add the colour number chosen at the end of the code.

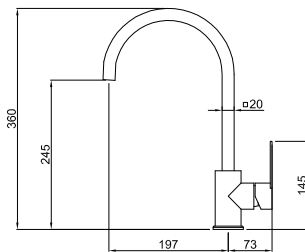

Metaltek 79 aluminium finish



Vitrotek 86/40 black finish



Granitek 68 bianco titano finish



Granitek 51 avena finish







Titan



Lever mixer with high, swivel spout and pull-out shower. Mixer hole dimensions: Ø 35 mm.

Available colours:
(see inside cover pages)

FINISH	CODE
Chrome	MIKTITCR
Metatek 79 aluminium	MMKTIT79
Granitek 52 bianco	MGKTIT52
51 avena	MGKTIT51

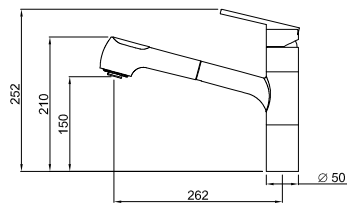

chrome finish



Metatek 79 aluminium finish



Granitek 51 avena finish



Granitek 52 bianco finish

Anticlogging shower.

The integrated anticlogging filter sifts more and more deposits and particles, which could obstruct the water flow.



elleci mixers

Reno Plus



Lever mixer with swivel spout and pull-out shower. Double water jet: areated and shower.

Mixer hole dimensions: Ø 35 mm.

FINISH	CODE
Chrome	MIKREPCR
Vitrotek	MVKREP
Metaltek	MMKREP
Granitek	MGKREP

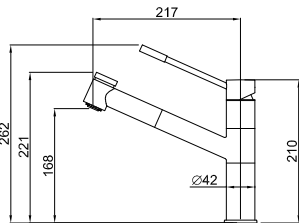

Vitrotek 86/40 black finish



Shower



Swivel supplier with pull-out shower. Light pression to switch jet water, from areated to shower.

Available colours:
(see inside cover pages)

Vitrotek finish:
96 white - 86/40 black

Metaltek finish:
79 aluminium - 73 titanium

Granitek finish:
62 bianco antico - 51 avena

To complete your order add the colour number chosen at the end of the code.



Metaltek 79 aluminium finish



chrome finish



Granitek 62 bianco antico finish

Reno

Lever mixer with swivel spout and pull-out shower.

Mixer hole dimensions: Ø 35 mm.

FINISH	CODE
Chrome	MIKRENCR
Vitrotek	MVKREN
Metaltek	MMKREN
Granitek	MGKREN

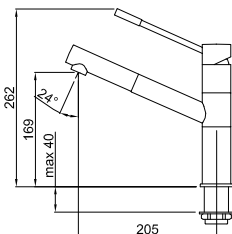

Granitek 43 tortora finish



Shower

Available colours:
(see inside cover pages)

Vitrotek finish:
96 white - 86/40 black

Metaltek finish:
79 aluminium - 77 chromium
73 titanium - 72 rame - 70 ghisa

Granitek finish:
62 bianco antico - 59 antracite
* 55 grigio u.s.l. - 52 bianco
51 avena - 43 tortora (new)

To complete your order add the colour number chosen at the end of the code.

* (u.s.l.) until stock lasts



Vitrotek 96 white finish



Metaltek 73 titanium finish



Vitrotek 86/40 black finish

Sava

Lever mixer with swivel spout.
Mixer hole dimensions: Ø 35 mm.

Available colours:
(see inside cover pages)

Vitrotek finish:
96 white - 86/40 black

Metaltek finish:
79 aluminium - 77 chromium
73 titanium - 72 rame - 70 ghisa

Granitek finish:
62 bianco antico - 59 antracite
*55 grigio u.s.i.
52 bianco - 51 avena

To complete your order add
the colour number chosen
at the end of the code.

* (u.s.i.) until stock lasts

FINISH	CODE
Chrome	MIKSAVCR
Vitrotek	MVKSAV
Metaltek	MMKSAV
Granitek	MGKSAV

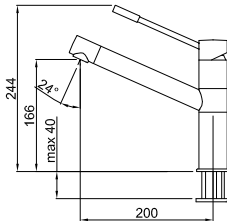

Metaltek 79 aluminium finish



Vitrotek 86/40 black finish



Metaltek 72 rame finish



Granitek 62 bianco antico finish

260
261

Danubio

Lever mixer with round, swivel spout.
Mixer hole dimensions: Ø 35 mm.
Reclinable mixer for under-window
installation.

FINISH	CODE
Chrome	MIKDANCR
Brushed	MIKDANSP

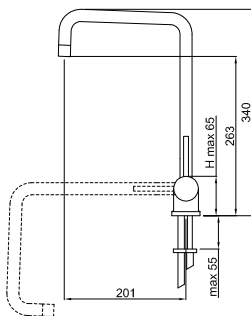

chrome finish



elleci mixers

Urano

Lever mixer with swivel spout and pull-out shower. Water jet switch: jet and shower. Mixer hole dimensions: Ø 35 mm.



FINISH	CODE
Chrome	MIKURACR
Granitek	MGKURA



Granitek 51 avena finish

Available colours:
(see inside cover pages)

Granitek finish:
62 bianco antico - 59 antracite
*53 terra u.s.i. - 52 bianco - 51 avena

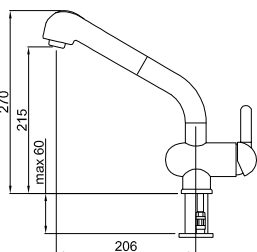

Granitek 62 bianco antico finish



Granitek 53 terra finish



Granitek 59 antracite finish

To complete your order add the colour number chosen at the end of the code.

* (u.s.i.) until stock lasts

Atena

Lever mixer with round, swivel spout. Mixer hole dimensions: Ø 35 mm.

FINISH	CODE
Chrome	MIKATECR
Granitek	MGKATE



Granitek 51 avena finish

Available colours:
(see inside cover pages)

Granitek finish:
54 nero - 52 bianco - 51 avena

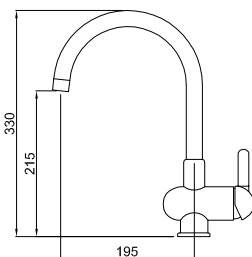

chrome finish



Granitek 52 bianco finish

To complete your order add the colour number chosen at the end of the code.

Po

Lever mixer with swivel spout.
Mixer hole dimensions: Ø 35 mm.

Available colours:
(see inside cover pages)

Metaltek finish:

79 aluminium - 77 chromium
73 titanium - 72 rame - 70 ghisa

Granitek finish:

68 bianco titano (new)
62 bianco antico - 61 pietra antica
59 antracite - *58 grigio ambra f.e.s.
57 pietra vecchia - 55 grigio u.s.l.
54 nero - 53 terra - 52 bianco
51 avena - 41 cacao - 40 full black

To complete your order add
the colour number chosen
at the end of the code.

* (u.s.l.) until stock lasts

FINISH	CODE
Chrome	MIKPOCR
Metaltek	MMKPO
Granitek	MGKPO

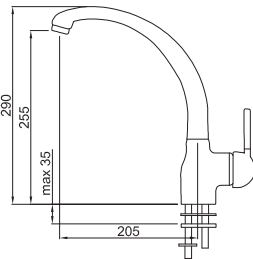

Granitek 51 avena finish



chrome finish



Metaltek 72 rame finish



Granitek 40 full black finish

262
263

Teseo

Lever mixer with swivel spout.
Mixer hole dimensions: Ø 35 mm.

Available colours:
(see inside cover pages)

Granitek finish:

68 bianco titano - 62 bianco antico
54 nero - 51 avena - 40 full black

To complete your order add
the colour number chosen
at the end of the code.

FINISH	CODE
Chrome	MIKTESCR
Granitek	MGKTES

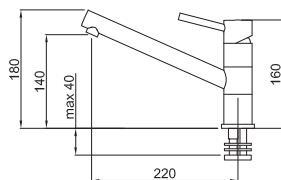

Granitek 51 avena finish



Granitek 40 full black finish



Granitek 68 bianco titano finish



Granitek 62 bianco antico finish

Senna

Lever mixer with swivel spout.
Mixer hole dimensions: Ø 35 mm.

FINISH	CODE
Chrome	MIKSENCR
Granitek	MGKSEN



Granitek 51 avena finish

Available colours:
(see inside cover pages)

Granitek finish:
62 bianco antico
61 pietra antica - 59 antracite
* 58 grigio ambra u.s.l.
57 pietra vecchia - 54 nero
53 terra - 52 bianco
51 avena - 41 cacao

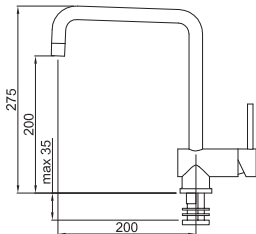

chrome finish



Granitek 52 bianco finish



Granitek 59 antracite finish

To complete your order add the colour number chosen at the end of the code.

* (u.s.l.) until stock lasts

Venere

Lever mixer with swivel spout and pull-out shower. Water flow switch: from jet to shower.
Mixer hole dimensions: Ø 35 mm.

FINISH	CODE
Chrome	MIKVENCN
Metaltek	MMKVEN
Granitek	MGKVEN



Granitek 51 avena finish

Available colours:
(see inside cover pages)

Metaltek finish:
79 aluminium - 77 chromium
73 titanium - 72 rame - 70 ghisa

Granitek finish:
68 bianco titano - 62 bianco antico
61 pietra antica - 59 antracite
* 58 grigio ambra u.s.l.
57 pietra vecchia - 55 grigio
54 nero - 53 terra - 52 bianco
51 avena - 41 cacao - 40 full black

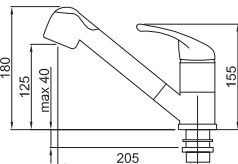

Metaltek 72 rame finish



Granitek 77 chromium finish



Granitek 40 full black finish

To complete your order add the colour number chosen at the end of the code.

* (u.s.l.) until stock lasts

Minerva

Lever mixer with tubular, swivel spout.
Mixer hole dimensions: Ø 35 mm.

Available colours:
(see inside cover pages)

Metaltek finish:

79 aluminium - 77 chromium
73 titanium - 72 rame - 70 ghisa

Granitek finish:

68 bianco titano - 62 bianco antico
61 pietra antica - 59 antracite
57 pietra vecchia - 55 grigio
54 nero - 53 terra - 52 bianco
51 avena - 41 cacao - 40 full black

FINISH	CODE
Chrome	MIKMINCR
Metaltek	MMKMIN
Granitek	MGKMIN

To complete your order add the colour number chosen at the end of the code.

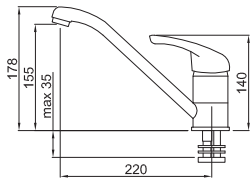

Granitek 51 avena finish



Metaltek 72 rame finish



Granitek 59 antracite finish



Granitek 52 bianco finish

264
265

Vulcano

Lever mixer with round, swivel spout.
Mixer hole dimensions: Ø 35 mm.
Reclinable for under-window installation.

Available colours:
(see inside cover pages)

Granitek finish:

54 nero - 52 bianco - 51 avena

FINISH	CODE
Chrome	MIKVULCR
Granitek	MGKVUL

To complete your order add the colour number chosen at the end of the code.

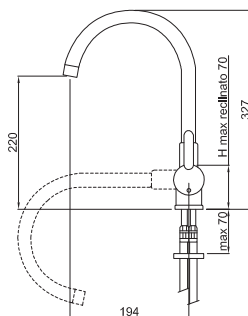

Granitek 51 avena finish



chrome finish



Granitek 52 bianco finish



Granitek 54 nero finish

elleci mixers

Queen



Leve mixer with high, swivel spout.
Mixer hole dimensions: Ø 35 mm.

FINISH	CODE
Chrome	MIKQUECR
Brass	MIKQUEOT
Granitek	MGKQUE



fin. Granitek 51 avena

Available colours:
(see inside cover pages)

Granitek finish:
62 bianco antico (new)
59 antracite (new) - 51 avena (new)

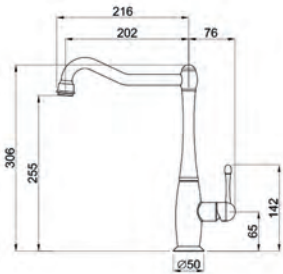

Granitek 51 avena finish



brass finish



fin. Granitek 59 antracite

To complete your order add
the colour number chosen
at the end of the code.



Rio

Lever mixer with high, swivel spout.
Mixer hole dimensions: Ø 35 mm.

Available colours:
(see inside cover pages)

Metaltek finish:
72 rame

Granitek finish:
62 bianco antico (new)
59 antracite (new) - 51 avena

FINISH	CODE
Chrome	MIKRIOCR
Brass	MIKRIOOT
Metaltek	MMKRIO
Granitek	MGKRIO

To complete your order add the colour number chosen at the end of the code.

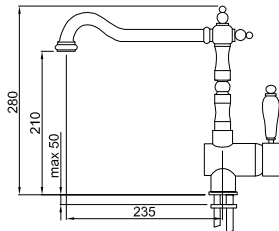

Granitek 51 avena finish



chrome finish



brass finish



Metaltek 72 rame finish

266
267

Tago

Double-lever-mixer with swivel spout.
Mixer hole dimensions: Ø 35 mm.

Available colours:
(see inside cover pages)

Granitek finish:
62 bianco antico
59 antracite - * 54 nero u.s.l.
52 bianco - 51 avena

FINISH	CODE
Chrome	MIKTAGCR
Brass	MIKTAGOT
Granitek	MGKTAG

To complete your order add the colour number chosen at the end of the code.

* (u.s.l.) until stock lasts

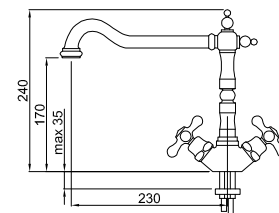

Granitek 51 avena finish



chrome finish



brass finish



Granitek 59 antracite finish

elleci mixers

Elba

Double-lever-mixer with round, swivel spout.
Mixer hole dimensions: Ø 35 mm.

FINISH	CODE
Chrome	MIKELBCR
Granitek	MGKELB



Granitek 51 avena finish

Available colours:
(see inside cover pages)

Granitek finish:
62 bianco antico
59 antracite - *54 nero u.s.l.
52 bianco - 51 avena

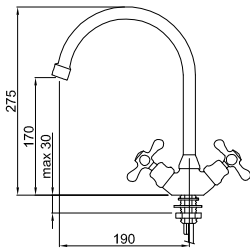

chrome finish



Granitek 52 bianco finish



Granitek 59 antracite finish

To complete your order add the colour number chosen at the end of the code.

* (u.s.l.) until stock lasts

BRASSY ACCESSORIES COLLECTION



Brassy accessories kit RIO
code AKRRIOOT



Brassy accessories kit TAGO
code AKRTAGOT



Brassy accessories kit ELBA
code AKRELBOT



Food Waste Disposer



Costant speed, direct current and lightweight reduces the vibrations and hence the noise, making each heat sink extremely quiet.

Food waste disposer is a modern appliance essential that frees us from wet waste food and makes our lives easier in the kitchen. Just pressing a button the food will be grinded and disposed. Easy to install, not bulky, quiet and safe. Food waste are reduced into small particles and discharged into the sewerage system through the water.

Grinding Area is the heart of **food waste disposer**:

- Made of stainless steel elements specifically designed to work into the water.
- Waste grinding blades, placed laterally inside the chamber for higher safety using.
- All plastic components are enriched with silver ions that generate an adequate antibacterial system crucial to remove all odours.
- Lower weight.
- Powered by current power (DC Motor).

268
269

Our food waste disposer are:
Made in Italy and
100% Italian designed.



Advantages: No bad odours anymore • Saving money • Waste reduction to be disposed • Easier disposal of no-organic wastes • Healthier environment • CO2 Reducing.

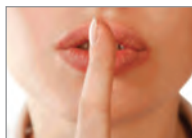

Extremely quiet: 40% less than the others

Equipped with sound insulation to reduce noise levels during operation.

Bigger grinding area

A bigger chamber volume means lower risk of jamming and better grinding.

Through this home appliance, you can dispose of all waste food as: fruits, vegetables, fish bones, eggshell, little chicken bones and many others. It is not possible to dispose of fibrous foods as: artichokes, fennels, pineapple, etc.



Stainless Steel High Quality Parts

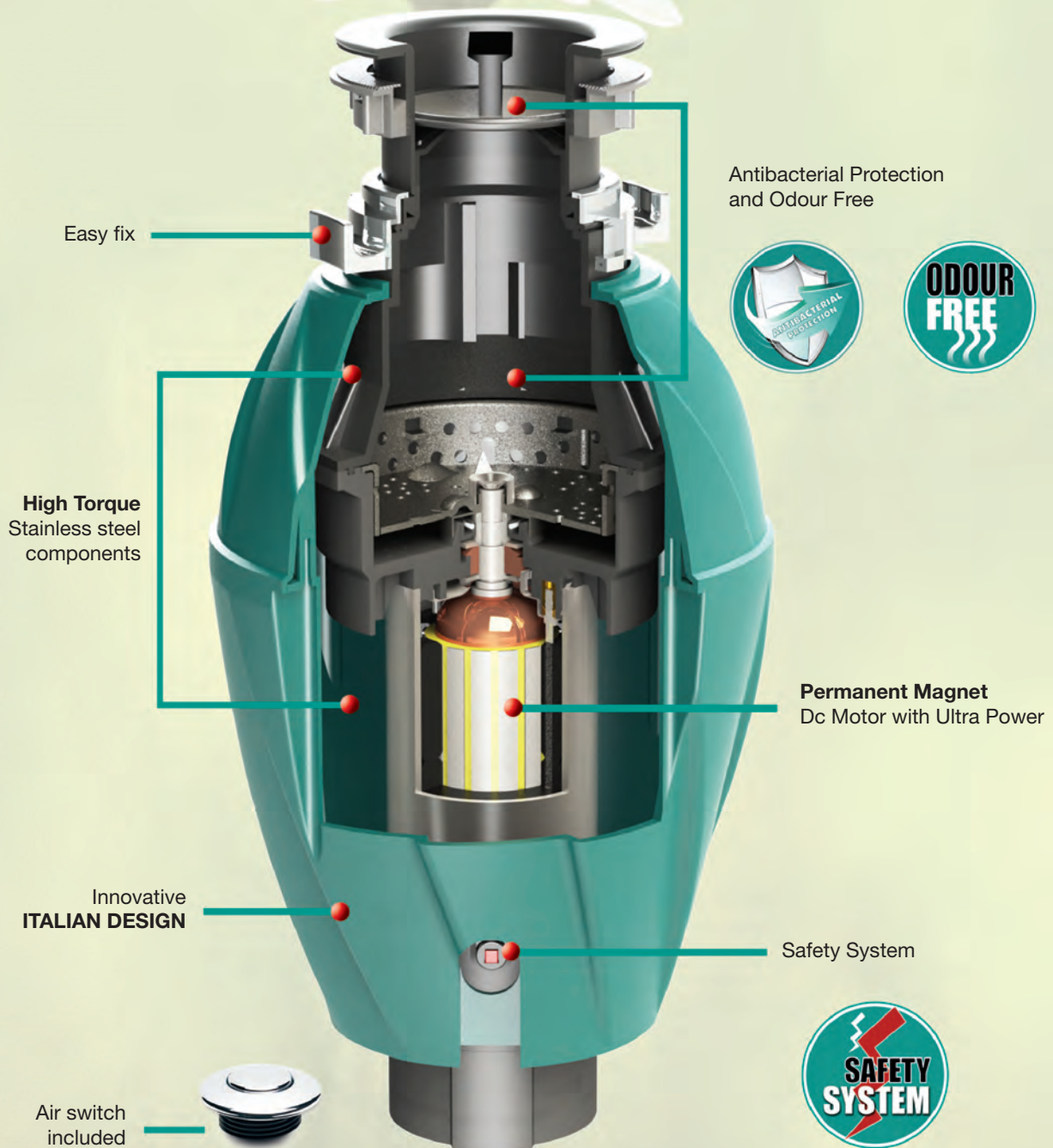

Food Waste Disposer Features: Green Power



SAFETY:

- **Thermal lock**, prevents overheating food waste disposer, automatically under protection.
- **Safety System**, reset security system.
- **EMC filter**, filter useful to limit electromagnetic damage.
- **Anti-lock**, tested to avoid any jamming and clogging.

DESIGN:

- **Helix shape carter** made of recyclable plastic in ABS-V2, 100% fire-proof.
- **Recyclable** packaging (no polystyrene).
- Paper info (warranty and brochure) of recycled paper (**FSC certification**).

INSTALLATION:

- Easy and quick.
- Installation available on both round and squared waste drain.
- Installation available also on one-bowl sinks, even with dishwasher connection on the same syphon.

INCLUDED ACCESSORIES:

- Waste pusher.
- Rubber splashguard, removable and washable (including dishwasher).
- Standard cap.
- Drain elbow.
- Pneumatic kit (power button by air, no electronic).

Separately, can also be ordered the Wireless Remote Control useful to avoid the hole on the working top for pneumatic button.



270
271

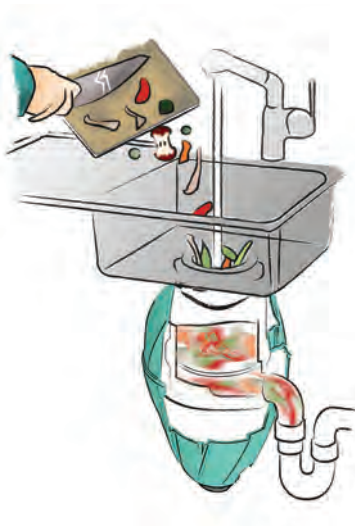

ANTIBACTERIAL TECHNOLOGY permanently molded into the components of our food waste disposers, inhibit the growth of micro organisms and eliminate bacteria-caused odours, bringing great sanitation and health to family.

Installed under the kitchen sink and connected to the drain, the food waste disposer is able to dispose the most of food garbage.

It is a small device to be connected to the kitchen draining water pipe, which shreds all the food waste or leftovers into pieces small enough in order that they can pass through plumbing, and together with water be disposed in the sewage system.

It is safe since it can be activated by a switch, which can be mounted both on the sink and on the working surface. It is safe also because it has not knives or blades: through centrifugal force the garbage is pushed against a toothed element and, by special little hammers, disposed in very small pieces. And finally it is safe because, during the functioning, you have no need to touch electrical switches.

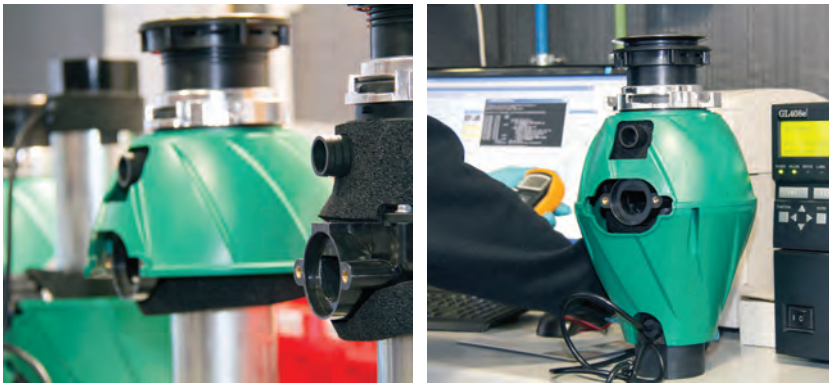

Our excellence is guaranteed by innovative tools, which allow a check during each single piece production.

At the end of line a check about functions and performance will be made following the above criteria:

- **Correct assembling.**
- **Electrical and thermal safety.**
- **Quality of design.**
- **Wet seal.**



Model 1000 TOP
 TDH01000
Deluxe 1 HP



INCLUDED ACCESSORIES:



Waste pusher.

Rubber splashguard, removable and washable (including dishwasher).

Standard cap.

Air switch: pneumatic kit (power button by air, no electronic).

Drain elbow.

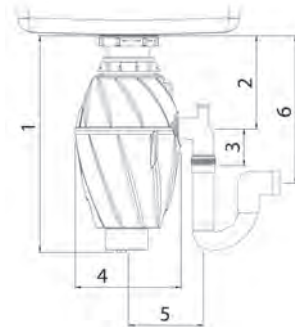

Model	Weight (Kg)	1	2	3	4	5	6
TDH01000	4,8	420	185	70	205	140	255

Power Watt 750 - Voltage VAC 220/240 - Absorbition (Ampere) 3,4 - r/min. 2800
Weight (kg) VAC 4,8 - Capacity: 1070 ml.

272
273



Model 750 TOP
 TDH00750
Heavy-Duty, 3/4 HP



INCLUDED ACCESSORIES:



Waste pusher.

Rubber splashguard, removable and washable (including dishwasher).

Standard cap.

Air switch: pneumatic kit (power button by air, no electronic).

Drain elbow.

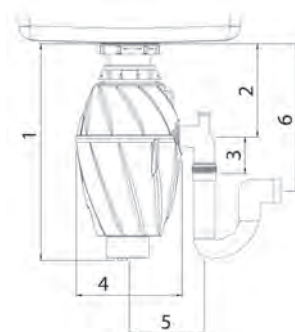

Model	Weight (Kg)	1	2	3	4	5	6
TDH00750	4,7	420	185	70	205	140	255

Power Watt 500 - Voltage VAC 220/240 - Absorbition (Ampere) 2,5 - r/min. 2800
Weight (kg) VAC 4,7 - Capacity: 1070 ml.



Model 750
TDM00750
Mid-Duty, 3/4 HP



INCLUDED ACCESSORIES:



Waste pusher.

Rubber splashguard, removable and washable (including dishwasher).

Standard cap.

Air switch: pneumatic kit (power button by air, no electronic).

Drain elbow.

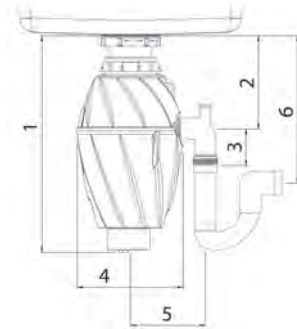

Model	Weight (Kg)	1	2	3	4	5	6
TDM00750	4,5	420	185	70	205	140	255

Power Watt 500 - Voltage VAC 220/240 - Absorbition (Ampere) 2,5 - r/min. 2800
Weight (kg) VAC 4,5 - Capacity: 860 ml.



Model 500 TOP
TDH00500
Heavy-Duty, 1/2 HP



INCLUDED ACCESSORIES:



Waste pusher.

Rubber splashguard, removable and washable (including dishwasher).

Standard cap.

Air switch: pneumatic kit (power button by air, no electronic).

Drain elbow.

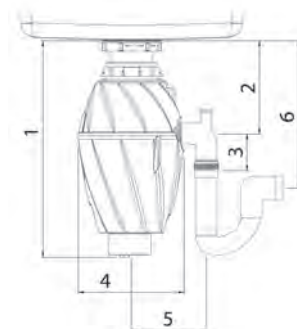

Model	Weight (Kg)	1	2	3	4	5	6
TDH00500	4,5	370	180	70	205	140	250

Power Watt 375 - Voltage VAC 220/240 - Absorbition (Ampere) 1,7 - r/min. 2800
Weight (kg) VAC 4,5 - Capacity: 1070 ml.



Model 500
TDM00500
Mid-Duty, 1/2 HP



INCLUDED ACCESSORIES:



Waste pusher.



Rubber splashguard, removable and washable (including dishwasher).



Standard cap.



Air switch: pneumatic kit (power button by air, no electronic).



Drain elbow.

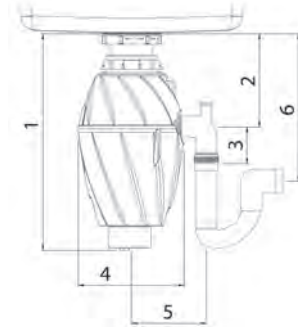

Model	Weight (Kg)	1	2	3	4	5	6
TDM00500	4,3	370	180	70	205	140	250

Power Watt 375 - Voltage VAC 220/240 - Absorbition (Ampere) 1,7 - r/min. 2800
Weight (kg) VAC 4,3 - Capacity: 860 ml.

274
275

Accessory:
Remote control
ARP01300



Features:

Design: Modern, Elegant, Steam lined.

DC Motor and grinding system: Permanent Magnet DC Motor with Ultra-Power (strong power).

Motor efficiency: 70-75% (high).

Grinding speed: Quick.

Vibration (dynamic balance grade): G0.4.

Stuck or jam: Never stuck, never jam.

Noise: Quiet.

Antibacterial Agent: Yes.

Note: Made in Italy.



Elleci suggests to show the following items: TDM00750 or TDH00750. On the top part it is possible to allocate around nr. 20 Green Power leaflets (code: LEAI009)

Display
ESPDISSEN



Food waste
disposers

Food waste disposer display

nr. 1 Green Power Display.
Bicolour display made of plexiglass transparent and green.

276
277



OVENS

COLLECTION

Models:

QUADRO

PLANO

BOMBÈ

Oven Collection



100% Made in Italy

All Elleci ovens are Made in Italy.



Class A Reduced energy consumption

Efficient, eco-friendly and saving. The energetic label allows the consumers to have a standard comparison between the household appliances energy consumptions. All Elleci ovens vaunt Class A, which guarantees efficiency and energy saving, while maintaining the utmost functioning performances.



Tangential Ventilation Cooling Fan

A forced system of air circulation contributes to reduce the heat transfer temperature both in the front and side of our ovens. The tangential ventilation is determined by a fan, which is automatically activated when the oven is turned on. The fan generates an airflow that comes out from the front grids, creating a barrier against the heat from the oven and in the same time cooling the oven handle and its control panel. Air circulation also creates a better heat insulation of electronic components and internal mechanism to ensure an improved reliability and length. In this way condensation is prevented, leaving the glass door always clear for a perfect interior view.



XL cooking space

The large 60 litres cooking space allows a total use with standard size accessories.



Easy Clean Enamel cooking space

By using the particular composition of (nickel-free) enamel, oven internal surfaces are non-stick and cooking space is easier to clean.



Triple glass oven door

Cold door, from which it's possible to see the whole cooking space.



Safe Door

Hypothermic thermal reflective glasses in the door-oven detain the heat produced by cooking, reducing its transmission to the external surface. Heat dispersion and energy consumption are thoroughly reduced.

278
279



Functions and features

Elleci ovens present progressive features both in performances, thanks to the most recent technological innovations, and in fashion and style.



INNER LIGHT:

Oven bulb (is always on during functioning).



DOUBLE UPPER GRILL RESISTANCE

WITH FAN: large ventilated grill area, regulating adjustment from 50°C to MAX



DOUBLE UPPER GRILL RESISTANCE:

large grill area, thermostat regulation from 50°C to MAX.



LOWER RESISTANCE FOR PASTRY:

in function the bottom resistance. Regulating thermostat from 50°C to MAX.



BROWING AND SMALL GRILL UPPER RESISTANCE:

reduced and area grill power, thermostat regulating from 50°C to 200°C.



TRADITIONAL COOKING LOWER AND UPPER RESISTANCE: in function the bottom and the resistance. Regulating thermostat from 50°C to MAX.



INTENSIVE COOKING UPPER AND LOWER RESISTANCE WITH FAN:

thermostat regulating from 50°C to MAX.



COOK ON MULTIPLE LEVELS CIRCULAR RESISTANCE WITH FAN: regulating thermostat from 50°C to MAX. Hot air is uniformly distributed on different levels.



PIZZA AND BREAD. LOWER AND CIRCULAR RESISTANCE WITH FAN: thermostat regulating from 50°C to MAX.

INSET HOLE TECHNICAL DRAWING VALID FOR ALL ELLECI OVENS

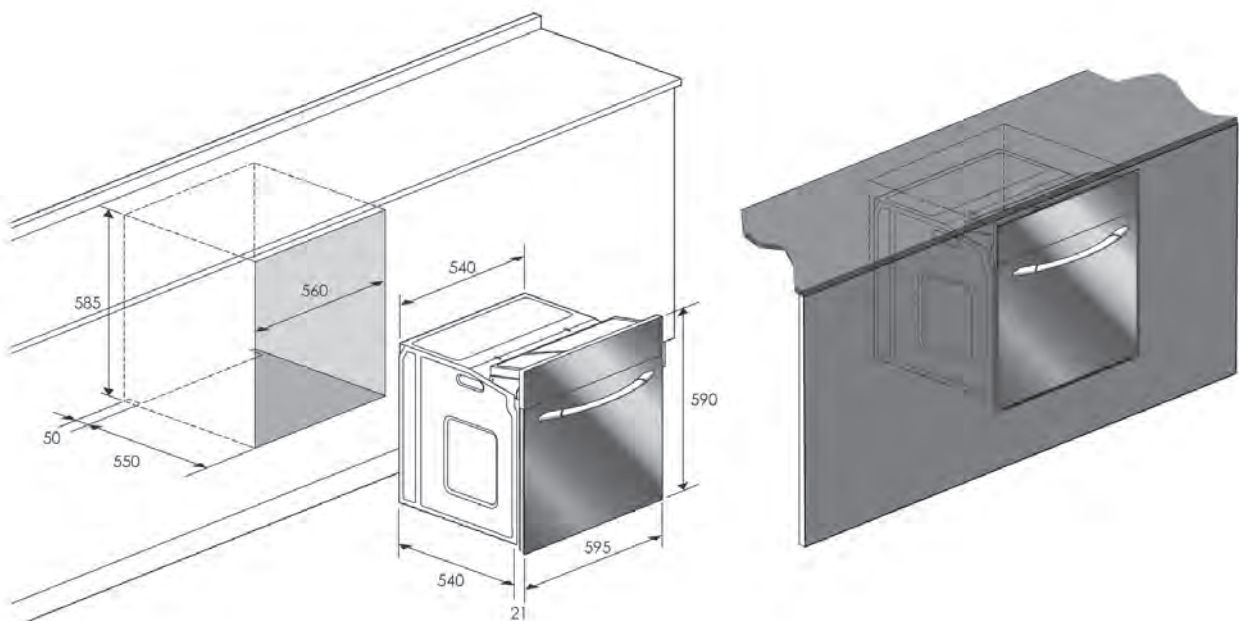

Quadro oven

new

FINISH	CODE
Vitrotek	
96 white	FVWQ60196NS
86 black/full black	FVWQ60186NS
Metatek	
79 aluminium	FMVQ60179NS
73 titanium	FMVQ60173NS



Vitrotek 96 white

Technical drawing (see page 279)



Tangential Ventilation Cooling Fan



Easy Clean Enamel cooking space



Triple glass oven door



Full glass inner door



280
281



- Dimensions: **600 x 600** mm
- Multifunctional electric oven
- Available in Metatek and Granitek finishes
- Triple glass oven door and glass control panel
- Telescopic rails, 100% extraction
- XL 60 litre Easy Clean Enamel cooking space
- Silver handle and knobs
- Inner light

- **Performances:**
9 functions (pizza function)
Timer digital touch control
Energetic efficiency Class **A**

- **Safety:**
Safe door
Tangential cooling fan

- **Included accessories:**
nr. 1 dripping pan
nr. 1 metallic grid
Muffle with nr. 2 telescopic rails
Connection cable

- **100% Made in Italy**



Ovens

QUADRO OVEN
Vitrotek 3G: 96 white

Quadro Collection

Pure and transparent,
as only the glass can be.



Vitrotek 86 black/full black



Total extraction telescopic slides
Using oven dishes and oven itself is easier by the helping of the stainless steel rails (100% extractable).



Metaltek 79 aluminium



Triple glass door
The door, including three hypothermic glasses, guarantees an reduced temperature on the most external glass.

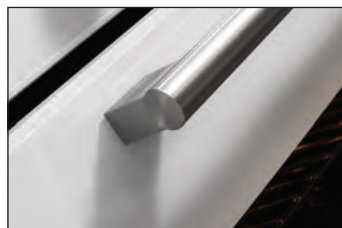

Cold door



Metaltek 73 titanium

282
283



QUADRO OVEN
Vitrotek 96 white

Plano oven

new

FINISH	CODE
Stainless steel	FIAP601INNS
Metatek	
79 aluminium	FMSP60179NS
73 titanium	FMSP60173NS
Granitek	
68 bianco titano	FGSP60168NS
51 avena	FGSP60151NS
40 full black	FGSP60140NS

Technical drawing (see page 279)



Tangential Ventilation Cooling Fan



Easy Clean Enamel cooking space



Full glass inner door



Granitek 40/86 full black



284
285



- Dimensions: **600 x 600 mm**
- Multifunctional electric oven
- Available in Metatek and Granitek finishes
- Double glass door
- Chamfered guides
- XL 60 litre Easy Clean Enamel cooking space
- Silver handle and knobs
- Inner light

• **Performances:**

- 5 functions
- Clock with end cooking alarm
- Energetic efficiency Class **A**

• **Safety:**

- Safe door
- Tangential cooling fan

• **Included accessories:**

- nr. 1 dripping pan
- nr. 1 metallic grid
- Muffle with nr. 2 telescopic rails
- Connection cable

• **100% Made in Italy**



ACCESSORIES	CODE
black knob soft touch	AMP40301

Available colours Oven **PLANO** (see inside cover pages)



Plano
Collection
Design and
technology
combine in a
new simplicity
concept.



Metaltek 79 aluminium



Granitek 51 avena



Metaltek 73 titanium



Stainless steel



Granitek 68 bianco titano

286
287



PLANO OVEN
Granitek 40 full black

Bombè oven

new

FINISH	CODE
Metaitek	
72 rame	FMSB60272NY
Granitek	
62 bianco ant.	FGSB60262NY
59 antracite	FGSB60259NY
51 avena	FGSB60251NY



Granitek 62 bianco antico



Tangential Ventilation Cooling Fan



Easy Clean Enamel cooking space



Full glass inner door



288
289



Metaitek 72 rame



Granitek 59 antracite



Granitek 51 avena

- Dimensions: **600 x 600 mm**
- Multifunctional electric oven
- Available in Metaitek and Granitek finishes
- Double glass door and printed and painted steel control panel
- Chamfered guides
- XL 60 litre cooking Easy Clean Enamel space
- Brassy handle and knobs
- Inner light

- **Performances:**
- 5 functions
- Clock with end cooking alarm
- Energetic efficiency Class **A**

- **Safety:**
- Safe door
- Tangential cooling fan

- **Included accessories:**
- nr. 1 dripping pan
- nr. 1 metallic grid
- Muffle with nr. 2 telescopic rails
- Connection cable

- **100% Made in Italy**

Available colours Oven **BOMBÈ** (see inside cover pages)



BOMBÈ OVEN
Granitek 62 bianco antico

elleci cooking tops

290
291



COOKING TOPS

COLLECTION

Models:

QUADRO

PLANO

BOMBÈ

STYLE

Cooking Tops Collection



100% Made in Italy

All Elleci cooking tops are Made in Italy.

General features

Elleci cooking tops sum up technological innovation and aesthetic creation, they elegantly fit any kind of kitchen furniture and they are the result of the Mediterranean culinary tradition. Their design aims to satisfy the most demanding expectations of those who use them every day.

Enamelled hob

Elleci pays particular attention to the design of its products in order to obtain solid and functional structures with innovative style. Our enameled cooking hob collection enriches each home with refined beauty.

Cast iron pan supports

The cast iron pan supports, proposed in the new collections, are designed to offer a clean aesthetic, preserving the efficiency of the burners, avoiding any dispersion of heat. Heavy-duty cast iron pan supports thanks to a special coating.

Crystal top

The new collection "Quadro" is made of a glass surface with a thickness of 8 mm, bevelled on all four sides, it ensures an adequate thermal resistance and high durability of the product.

292
293

GAS:
cleaner
than other
fossil fuels,
flexibility
of operation
on devices,
cutting-edge
extraction
technology.



Functionalities and features

Elleci cooking tops present advanced features both in performances, thanks to the most recent technological innovations, and in most current fashion and style.



AUTOMATIC UNDER KNOB IGNITION SYSTEM

It is sufficient to press and, at the same time, rotate the knob until both gas supply and sparks, necessary to ignite the burner, are activated.



SAFETY VALVE

GasProtekt: it stops gas supply in case of accidental switching off.



CAST IRON PAN SUPPORT

The pan support plays an essential role. Sturdy, heavy, stable, beautiful and perfectly functional, they are able to transfer a suspension feeling while maintaining utmost stability to every kind of pan. The absence of sharp edges for an easy cleaning.



BURNERS

A triple crown (nr. 3 powerful fire circles) is able to develop and evenly distribute the heat, reducing the cooking time accordingly. The better distribution of heat under the pot maximizes power and enables a fast and homogeneous cooking.



Quadro 120

new

FINISH	CODE
Vitrotek 96 white	PVCQ120196DS
Metaltek 79 aluminium	PMCQ120179DS



Vitrotek 96 white

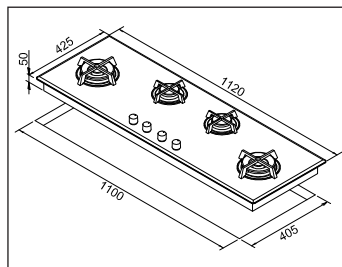

Metaltek 79 aluminium

294
295



- Dimensions: **1120 x 425 mm**
- Built-in gas hob
- Inset hole: **1100 x 405 mm**
- Power (W) semirapid: 1.75 - triple crown: 3.35
- Tempered glass hob, bevelled edge
- nr. 4 gas burners of which nr. 2 lateral triple crowns
- Cast iron pan supports
- Automatic under knob ignition system
- Silver knobs
- Black matt finish burner covers
- Connecting cable
- Safety valve
- **100% Made in Italy**



Quadro 70 TCC new!

FINISH	CODE
Vitrotek	
96 white	PVCQ70196CS
86 black/full black	PVCQ70186CS
Metaltek	
79 aluminium	PMCQ70179CS
73 titanium	PMCQ70173CS



Metaltek 79 aluminium

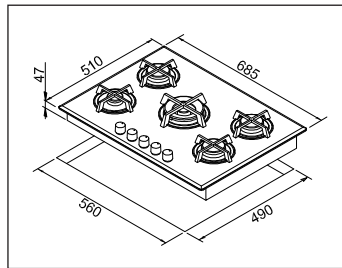

296
297



Vitrotek 96 white



Vitrotek 86 black/full black



Metaltek 73 titanium

- Dimensions: **685 x 510 mm**
- Built-in gas hob
- Inset hole: **560 x 490 mm**
- Power (W) auxiliary: 1.0 - semirapid: 1.75
rapid: 3.0 - triple crown: 3.35
- Tempered glass hob, bevelled edge
- nr. 5 gas burners of which one central triple crown
- Cast iron pan supports
- Automatic under knob ignition system
- Silver knobs
- Black matt finish burner covers
- Connecting cable
- Safety valve
- **100% Made in Italy**



Quadro 60 TCL new!

FINISH	CODE
Vitrotek	
96 white	PVCQ60196WS
86 black/full black	PVCQ60186WS
Metaltek	
79 aluminium	PMCQ60179WS
73 titanium	PMCQ60173WS



Metaltek 73 titanium

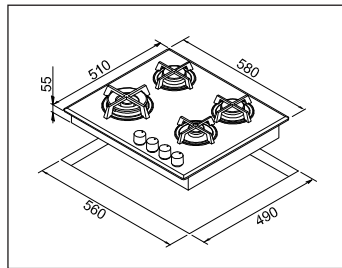

298
299



- Dimensions: **580 x 510 mm**
- Built-in gas hob
- Inset hole: **560 x 490 mm**
- Power (W) auxiliary: 1.0 - semirapid: 1.75 - triple crown: 3.35
- Tempered glass hob, bevelled edge
- nr. 4 gas burners of which one lateral triple crown
- Cast iron pan supports
- Automatic under knob ignition system
- Silver knobs
- Black matt finish burner covers
- Connecting cable
- Safety valve
- **100% Made in Italy**

elleci cooking tops



Vitretek 96 white



Vitretek 86 black/full black



Metaltek 79 aluminium

Plano 75 TCC

new

FINISH	CODE
Stainless steel	PIAP751INCS
Metaltek	
79 aluminium	PMSP75179CS
73 titanium	PMSP75173CS
Granitek	
68 bianco titano	PGSP75168CS
51 avena	PGSP75151CS
40 full black	PGSP75140CS



Metaltek 73 titanium

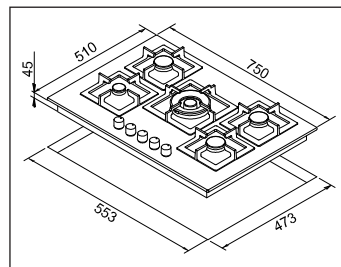

300
301



Metaltek 79 aluminium



Granitek 51 avena



Granitek 40/86 full black



Stainless steel



Granitek 68 bianco titano

- Dimensions: **750 x 510 mm**
- Built-in gas hob
- Inset hole: **553 x 473 mm**
- Power (W) auxiliary: 1.0 - semirapid: 1.75
rapid: 3.0 - triple crown: 4.0
- Enamelled hob
- nr. 5 gas burners
of which one central triple crown
- Cast iron pan supports
- Automatic under knob ignition system
- Silver knobs
- Black matt finish burner covers
- Connecting cable
- Safety valve
- **100% Made in Italy**



Plano 60 TCL

new

FINISH	CODE
Stainless steel	PIAP6011NWS
Metaltek	
79 aluminium	PMSP60179WS
73 titanium	PMSP60173WS
Granitek	
68 bianco titano	PGSP60168WS
51 avena	PGSP60151WS
40 full black	PGSP60140WS



Granitek 40/86 full black

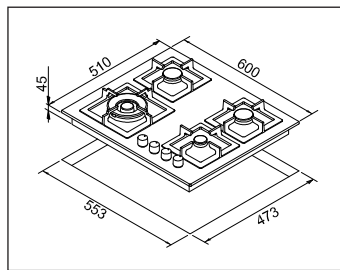

302
303



Metaltek 79 aluminium



Granitek 51 avena



Metaltek 73 titanium



Stainless steel



Granitek 68 bianco titano

- Dimensions: **600 x 510 mm**
- Built-in gas hob
- Inset hole: **553 x 473 mm**
- Potenza (W) auxiliary: 1.0 - semirapid: 1.75
triple crown: 4.0
- Enamelled hob
- nr. 4 gas burners
of which one lateral triple crown
- Cast iron pan supports
- Automatic under knob ignition system
- Silver knobs
- Black matt finish burner covers
- Connecting cable
- Safety valve
- **100% Made in Italy**



elleci

Bombè 75 TCC new!

FINISH	CODE
Metaltek	
72 rame	PMSB75272CY
Granitek	
62 bianco ant.	PGSB75262CY
59 antracite	PGSB75259CY
51 avena	PGSB75251CY



Granitek 62 bianco antico

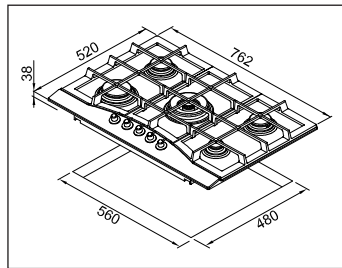

304
305



Metaltek 72 rame



Granitek 59 antracite



Granitek 51 avena

- Dimensions: **762 x 520** mm
- Built-in gas hob
- Inset hole: **560 x 480** mm
- Power (W) auxiliary: 1.0 - semirapid: 1.75
rapid: 3.0 - triple crown: 3.35
- nr. 5 gas burners
of which one central triple crown
- Cast iron pan supports
- Automatic under knob ignition system
- Brass knobs
- Black matt finish burner covers
- Connecting cable
- Safety valve
- **100% Made in Italy**



Bombè 60 TCL new!

FINISH	CODE
Metaltek	
72 rame	PMSB60272WY
Granitek	
62 bianco ant.	PGSB60262WY
59 antracite	PGSB60259WY
51 avena	PGSB60251WY



Granitek 62 bianco antico

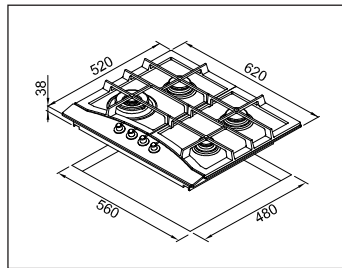

306
307



Metaltek 72 rame



Granitek 59 antracite



Granitek 51 avena

- Dimensions: **620 x 520 mm**
- Built-in gas hob
- Inset hole: **560 x 480 mm**
- Power (W) auxiliary: 1.0 - semirapid: 1.75
triple crown: 3.35
- nr. 4 gas burners
of which one lateral triple crown
- Cast iron pan supports
- Automatic under knob ignition system
- Brass knobs
- Black matt finish burner covers
- Connecting cable
- Safety valve
- **100% Made in Italy**



Style 90 TCC

FINISH	CODE
Stainless steel	PIAS902INCSG
Granitek	
51 avena	PGSS90251CNG



Granitek 51 avena

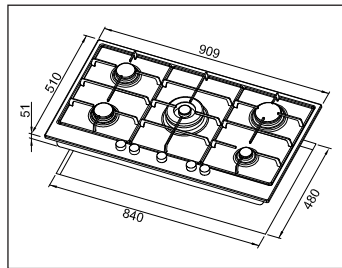

308
309



Stainless steel

- Dimensions: **909 x 510** mm
- Built-in gas hob
- Inset hole: **840 x 480** mm
- Power (W) auxiliary: 1.0 - semirapid: 1.75
rapid: 3.0 - triple crown: 3.35
- nr. 5 gas burners of which one central triple crown
- Cast iron pan supports
- Automatic under knob ignition system
- Black or silver knobs
- Black matt finish burner covers
- Connecting cable
- Safety valve
- **100% Made in Italy**

ACCESSORIES	CODE
brassy knob (pcs 1)	AMP40302
glass cover for Style 90 u.s.l.	ACV04301

* (u.s.l.) until stock lasts



5 brassy knobs needed for this model



glass matt cover

Style 75 TCL

FINISH	CODE
Stainless steel	PIAS752INLSG
Granitek	
51 avena	PGSS75251LNG



Granitek 51 avena

cast iron grid

Enamelled grid

FINISH	CODE
Stainless steel	PIAS752INLS
Granitek	
51 avena	PGSS75251LN



enamelled grid

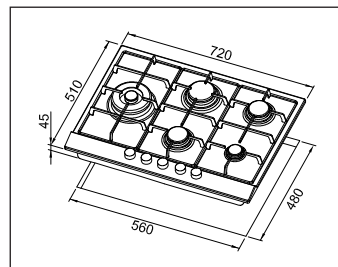

Stainless steel

- Dimensions: **720 x 510** mm
- Built-in gas hob
- Inset hole: **560 x 480** mm
- Power (W) auxiliary: 1.0 - semirapid: 1.75
rapid: 3.0 - triple crown: 3.35
- nr. 5 gas burners of which one lateral triple crown
- Cast iron or enamelled grids
- Automatic under knob ignition system
- Black or silver knobs
- Black matt finish burner covers
- Connecting cable
- Safety valve
- **100% Made in Italy**

ACCESSORIES	CODE
brassy knob (pcs 1)	AMP40302
glass cover for Style 75 u.s.i.	ACV03301

* (u.s.i.) until stock lasts



5 brassy knobs needed for this model



glass matt cover

Style 75 TCC

Cast iron grid

FINISH	CODE
Stainless steel	PIAS753INCSG
Metaltek	
79 aluminium	PMSS75379CSG
73 titanium	PMSS75373CSG
Granitek	
52 bianco	PGSS75352CNG
51 avena	PGSS75351CNG



Granitek 51 avena

cast iron grid



Stainless steel

Enamelled grid

FINISH	CODE
Stainless steel	PIAS753INCS
Metaltek	
79 aluminium	PMSS75379CN
73 titanium	PMSS75373CN
Granitek	
52 bianco	PGSS75352CN
51 avena	PGSS75351CN



enamelled grid

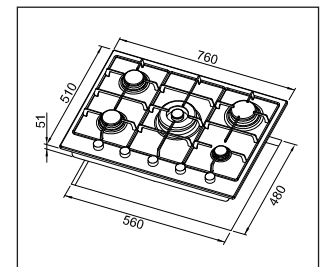

310
311



Metaltek 79 aluminium



Metaltek 73 titanium



Granitek 52 bianco

- Dimensions: **760 x 510 mm**
- Built-in gas hob
- Inset hole: **560 x 480 mm**
- Power (W) auxiliary: 1.0 - semirapid: 1.75
rapid: 3.0 - triple crown: 3.35
- nr. 5 gas burners of which one central triple crown
- Cast iron or enamelled grids
- Automatic under knob ignition system
- Black or silver knobs
- Black matt finish burner covers
- Connecting cable
- Safety valve
- **100% Made in Italy**

ACCESSORIES	CODE
brassy knob (pcs 1)	AMP40302
glass cover for Style 75 u.s.l.	ACV03301

* (u.s.l.) until stock lasts



5 brassy knobs needed for this model



glass matt cover

Style 60 TCL

Cast iron grid

FINISH	CODE
Stainless steel	PIAS602INWSG
Metaltek	
79 aluminium	PMSS60279WSG
73 titanium	PMSS60273WSG
Granitek	
52 bianco	PGSS60252WNG
51 avena	PGSS60251WNG



Granitek 51 avena

cast iron grid



Stainless steel

Enamelled grid

FINISH	CODE
Stainless steel	PIAS602INWS
Metaltek	
79 aluminium	PMSS60279WN
73 titanium	PMSS60273WN
Granitek	
52 bianco	PGSS60252WN
51 avena	PGSS60251WN



enamelled grid

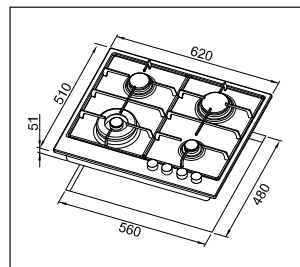

Metaltek 79 aluminium



Metaltek 73 titanium



Granitek 52 bianco

- Dimensions: **620 x 510** mm
- Built-in gas hob
- Inset hole: **560 x 490** mm
- Power (W) auxiliary: 1.0 - semirapid: 1.75
triple crown: 3.35
- nr. 4 gas burners of which one lateral triple crown
- Cast iron or enamelled grids
- Automatic under knob ignition system
- Black or silver knobs
- Black matt finish burner covers
- Connecting cable
- Safety valve
- **100% Made in Italy**

ACCESSORIES	CODE
brassy knob (pcs 1)	AMP40302
glass cover for Style 60 u.s.i.	ACV01302

* (u.s.i.) until stock lasts



4 brassy knobs needed for this model



glass matt cover

Style 60

Cast iron grid

FINISH	CODE
Stainless steel	PIAS603INNSG
Granitek	
52 bianco	PGSS60352NNG
51 avena	PGSS60351NNG



Granitek 52 bianco

cast iron grid

Enamelled grid

FINISH	CODE
Stainless steel	PIAS603INNS
Granitek	
52 bianco	PGSS60352NN
51 avena	PGSS60351NN



enamelled grid

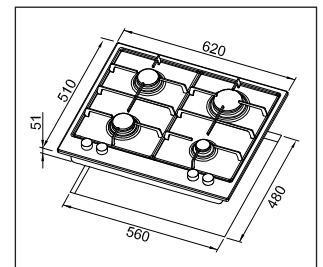

312
313



Stainless steel



Granitek 51 avena

- Dimensions: **620 x 510 mm**
- Built-in gas hob
- Inset hole: **560 x 480 mm**
- Power (W) auxiliary: 1.0 - semirapid: 1.75 - rapid: 3.0
- nr. 4 gas burners
- Cast iron or enamelled grids
- Automatic under knob ignition system
- Black or silver knobs
- Black matt finish burner covers
- Connecting cable
- Safety valve
- **100% Made in Italy**

ACCESSORIES	CODE
brassy knob (pcs 1)	AMP40302
glass cover for Style 60 u.s.l.	ACV01302

* (u.s.l.) until stock lasts



4 brassy knobs needed for this model



glass matt cover



314
315



HOODS

COLLECTION

Models:

QUADRO

PLANO

CRYSTAL

CURVE

Hoods Collection



100% Made in Italy

All Elleci cooker hoods are Made in Italy.

How to choose a hood

Before any other choice, it is important to identify the model of hood which aesthetically best suits to the furnishing of your kitchen and, in any case, reflects your own taste. Elleci offers a complete range both from a functional point of view and of the design, allowing a good match with our sinks, mixers, hobs and ovens: the SUITE Elleci.

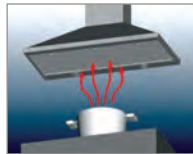

Hoods

All Elleci models can operate as extractor hood, in which air is evacuated outside. The hood is equipped with a particular valve that allows the expulsion of cooking vapours, but avoiding cold air penetrating from the outside into the house. In case there is no possibility draws off the air outside the dwelling, it is necessary to fit the hood with a charcoal filter (thus operating as a filtering hood), by means of which, air is purified and then fed back into the environment. This option requires a careful maintenance of the carbon filters. The pipe diameter must be adequate (at least 120 mm) and should not be excessively long and winding, as this will affect the performance of the hood.

316
317

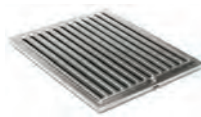

Grease filters

The grease filter is always needed having a dual function in the hood. The grease filter protects the internal parts of the hood, avoiding fat particles to affect the electrical components, especially the engine.



Charcoal filters

Charcoal filters should be mounted only when the hood is installed in suction version and act as real air purifiers. This feature is made possible by the enormous capacity of this vegetal material, the activated carbon, to retain particles and substances, before air is blown again into the environment. The charcoal filters cannot be washed or regenerated and must be replaced periodically. The saturation of the activated carbon depends, more or less, on the prolonged use of this device, the type of cooking and the regularity with which the grease filter is cleaned. Each Elleci hood is equipped with timer, intensive speed, filter saturation indicator and the **Clean Air** function, which ensures a continuous air exchange, in the complete absence of noise.



Clean Air

By keeping pushed Timer button for 3 seconds, Clean Air function automatically activates the hood for 10 minutes every hour, guaranteeing a continuous air exchange in the kitchen and even in the living room, when connected.

Functionalities and features

Elleci hoods present advanced features both in performances, thanks to the most recent technological innovations, and in most current fashion and style.



ACOUSTIC IMPACT

The advanced engine technology allows to increase the comfort even in case of high suction speed.

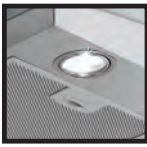

LIGHTING

All Elleci hoods are quipped with halogen lamps with a lower energetic consumption, they improve a lower energetic consumption, they improve the visibility combining it with energy saving.



TIMER

It offers three options: 10, 15, 20 minutes for the delayed switching off obtaining the perfect suction after any cooking.



Quadro hood



Dimension: 800 mm

FINISH	CODE
Vitretek	
96 white	KVQ80096VST
86 black	KVQ80086VST



86 black/full black finish

close

ACCESSORIES

Carbon filter
Code **AFC01300**

Air deflector kit with bracket
and mounting screws
Code **ADA01300**



96 white finish

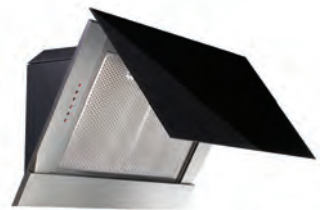

open

318
319

Controls:	soft touch lighting display
Speeds:	3+1
Clean Air system:	yes
Filter change signal:	yes
Timer:	yes
Booster:	yes
Lighting:	2x20 W halogene
Engine type:	HC3
Max capacity:	710 Mc/h
Pressure:	436 Pa
Max noise level:	53 dbA
Outlet size diameter:	150 mm
Grease filter:	included
Power supply connection:	220-240V/50Hz
Carbon filter:	accessory
Filtering hood kit:	accessory

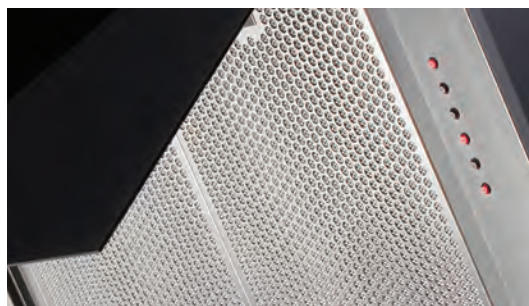
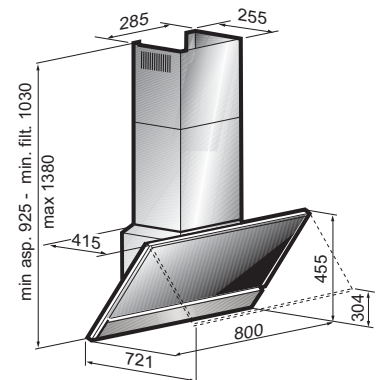

**Filtering hood
accessory:
air switch kit
ADA01300**

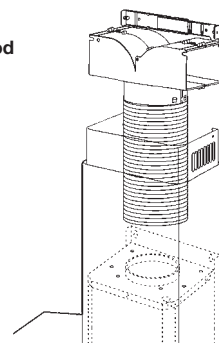



Elegant system to facilitate the opening and closing.

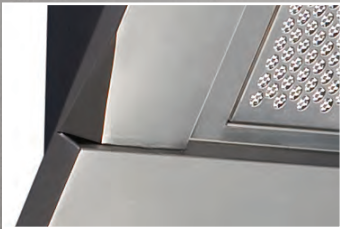

Halogen dichroic lamps. Less heat emission. Less power consumption.



Clean Air

By keeping pushed Timer button for 3 seconds, Clean Air function automatically activates the hood for 10 minutes every hour, for guaranteeing a continuous air exchange in the kitchen and even in the living room, when connected.

Plano hood

Dimension: 900 mm

FINISH	CODE
Stainless steel	KIP900INNTC
Vitrotek	
96 white	KVP90096NTC
86 black	KVP90086NTC
Metaltek	
79 aluminium	KMP90079NTC

ACCESSORIES

Carbon filter
Code **AFC01300**

Air deflector kit with bracket
and mounting screws
Code **ADA01300**



79 aluminium finish



96 white finish



86 black/full black finish



stainless steel finish

320
321

Controls:	touch control
Speeds:	3+1
Clean Air system:	yes
Filter change signal:	yes
Timer:	yes
Booster:	yes
Lighting:	2x20 W halogene
Engine type:	HC3
Max capacity:	703 Mc/h
Pressure:	436 Pa
Max noise level:	56 dbA
Outlet size diameter:	150 mm
Grease filter:	included
Power supply connection:	220-240V/50Hz
Carbon filter:	accessory
Filtering hood kit:	accessory

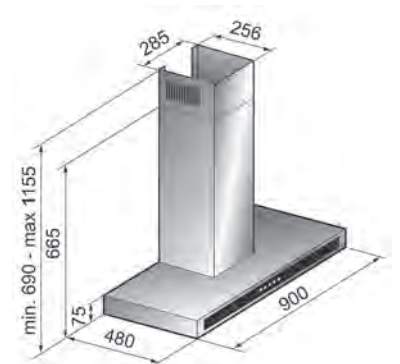

**Filtering hood
accessory:
air switch kit
ADA01300**

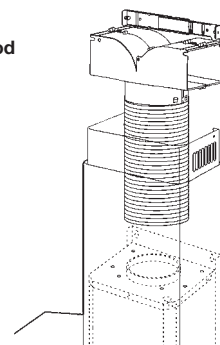

Available colours HOOD PLANO (see inside cover pages)



Clean Air

By keeping pushed Timer button for 3 seconds, Clean Air function automatically activates the hood for 10 minutes every hour, for guaranteeing a continuous air exchange in the kitchen and even in the living room, when connected.

Crystal hood

Dimension: 900 mm

FINISH	CODE
Stainless steel	KIC900INTST
Vitrotek	
96 white	KVC90096TST
86 black	KVC90086TST



finish 86 black/full black with trasparent glass

ACCESSORIES

Carbon filter
Code **AFC01300**

Air deflector kit with bracket
and mounting screws
Code **ADA01300**



finish 96 white with trasparent glass



finish stainless steel with trasparent glass

322
323

Controls:	soft touch lighting display
Speeds:	3+1
Clean Air system:	yes
Filter change signal:	yes
Timer:	yes
Booster:	yes
Lighting:	2x20 W halogene
Engine type:	HC3
Max capacity:	703 Mc/h
Pressure:	436 Pa
Max noise level:	56 dbA
Outlet size diameter:	150 mm
Grease filter:	included
Power supply connection:	220-240V/50Hz
Carbon filter:	accessory
Filtering hood kit:	accessory

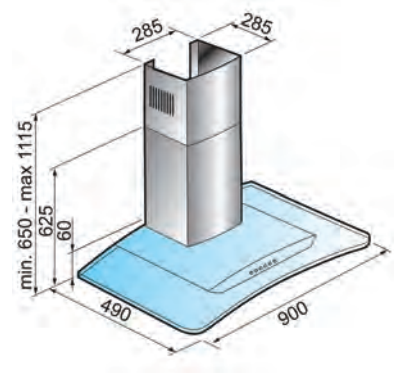

**Filtering hood
accessory:
air switch kit
ADA01300**

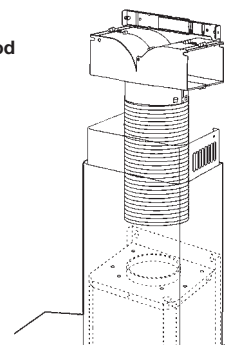

Available colours HOOD **CRYSTAL** (see inside cover pages)



Clean Air

By keeping pushed Timer button for 3 seconds, Clean Air function automatically activates the hood for 10 minutes every hour, for guaranteeing a continuous air exchange in the kitchen and even in the living room, when connected.

Curve hood

Dimension: 900 mm

FINISH	CODE
Stainless steel	KIU900INAPM
Metaltek 72 rame	KMU90072APM
Granitek 51 avena	KGU90051APM



72 rame finish

ACCESSORIES

Carbon filter
Code **AFC01300**

Air deflector kit with bracket
and mounting screws
Code **ADA01300**



stainless steel finish



51 avena finish

324
325

Controls:	mechanical push-button with indicator light
Speeds:	3+1
Clean Air system:	yes
Filter change signal:	yes
Timer:	yes
Booster:	yes
Lighting:	2x20 W halogene
Engine type:	HC3
Max capacity:	703 Mc/h
Pressure:	436 Pa
Max noise level:	56 dbA
Outlet size diameter:	150 mm
Grease filter:	included
Power supply connection:	220-240V/50Hz
Carbon filter:	accessory
Filtering hood kit:	accessory

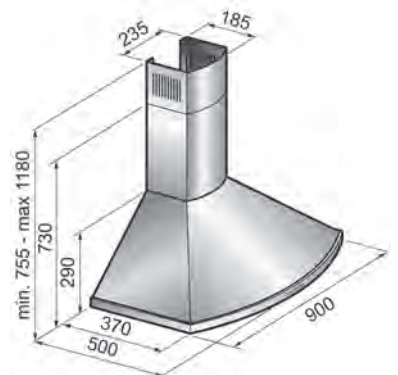

**Filtering hood
accessory:
air switch kit
ADA01300**

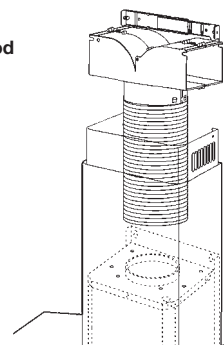

Available colours HOOD **CURVE** (see inside cover pages)



Clean Air

By keeping pushed Timer button for 3 seconds, Clean Air function automatically activates the hood for 10 minutes every hour, for guaranteeing a continuous air exchange in the kitchen and even in the living room, when connected.

Accessories

A richer and studied accessories outfit features our sink proposals. For each of our model a accessories series is provided for enriching the aesthetics and functionality of our sinks. We studied integrated systems of accessories, which exploit each of your movement.

326
327



The wide range of cutting boards includes wooden proposals, particularly wear and tear resistant, for ensuring hygiene and long lasting. Solutions made up of glass and plastic materials complete our offer. Baskets, bowls and dish-drainers enrich the range for helping you in your kitchen activities.



elleci accessories

Dim.: 490 x 323 mm



ATP01300
Polyethylene
chopping board

01

Dim.: 421 x 291 x 188 mm



ACI01300
Basket

02

Dim.: 485 x 200 x 165 mm



AVP02001
Polycarbonate
bowl

03

Dim.: 540 x 300 mm



ATL01000
Sliding wooden
chopping board

04

Dim.: 322 x 194 x 95 mm



AVI03001
Colander

05

Dim.: 420 x 300 mm



ATL01001
Wooden chopping board
with insert HPE (178 x 178 mm)

06

Dim.: 541 x 310 mm



ATV01000
Sliding glass
chopping board

07

Dim.: Ø 345 mm



ACI02300
Basket
Ego Round

08

Dim.: 300 x 185 x 82 mm



ADI01300
Dish drainer

09

Dim.: Ø 435 mm



ATL02300
Wooden chopping board
Ego Round

10

Dim.: 405 x 312 x 195 mm



ACI03300
Basket
Fox 360

11

Dim.: 475 x 414 mm



ATL03000
Wooden chopping board
Fox 360

12

Dim.: 301 x 144 mm



ATP01301
Polyethylene
chopping board

13

Dim.: 301 x 144 x 132 mm



AVP01301
Polycarbonate bowl

14

Dim.: Ø 320 mm



ACI02301
Basket Round

15

Dim.: Ø 395 mm



ATL02301
Wooden chopping board
Round

16

Dim.: 299 x 384 x 175 mm



ACI01301
Basket

17

Dim.: 446 x 352 mm



ATP03300
Wooden chopping board

19

Dim.: 541 x 310 mm



ATV01001
Glass sliding
chopping board

24



ADI02300
Round
soap dispenser

25

elleci accessories

Dim.: 500 x 310 mm



ATV01002 *by SCHOTT*
Sliding Glass
chopping board matt white

26

Dim.: 500 x 310 mm



ATV01003 *by SCHOTT*
Sliding Glass
chopping board matt black

27

Dim.: 402 x 270 x 190 mm



ACI01303
Basket

28

Dim.: 348 x 324 x 112 mm



ACI01304
Basket
drainer

30

Dim.: 428 x 336 x 170 mm



ACI11300
Basket

35

Dim.: 500 x 502 x 70 mm

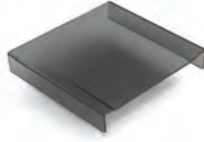

ACP05600
Lexan cover/sliding
drainer

36

Dim.: 305 x 476 mm



ATL12600
Wooden
chopping board

37

Dim.: 305 x 476 mm



ATL11600
Wengè wooden
chopping boards

37.1

Dim.: 915 x 476 mm



AKT12600
Nr. 3 wooden
chopping boards

38

Dim.: 915 x 476 mm



AKT11600
Nr. 3 wengè wooden
chopping boards

38.1

Dim.: 500 x 310 mm



ATL01002
Wooden
chopping board

39

Dim.: 405 x 340 mm



ARI01300
Rollmat

42

Dim.: 370 x 300 mm

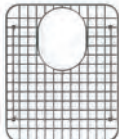

AGB01300
Bottom grid

43

Dim.: 375 x 435 mm



ATL01303
Wooden chopping board
Sky 360

46

Dim.: 274 x 148 x 63 mm



AVI03002
Bowl
Sky 360

47

Dim.: 270 x 137 x 60 mm



AVP01302
Polycarbonate bowl
Sky 360

48

Dim.: 375 x 250 x 190 mm



ACI01305
Basket
Sky 360

49



ADI02301
Compact and squared soap
dispenser (H. 40 mm)

50

Dim.: 250 x 400 x 70 mm

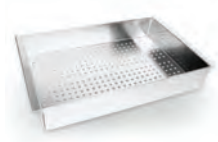

AVI03303
Colander
Value

51

elleci accessories

Dim.: 246 x 213 x 68 mm



ADI01301
Flat drainer
Value

52



ATQ01300
Squared food waste
disposer flange

54

new



ACA01300
Value 130 stainless steel
and food silicone E-cover

55

Dim.: 72 x 404 mm cadauno



AKD013_ (color number)
Nr. 4 staves in composite
material Value 130

56

new

Dim.: 195 x 327 mm



AGD01300
Drainer
Easy S

57

new

Dim.: 275 x 262 mm



AGD01302
Drainer
Easy M

58

new

Dim.: 275 x 327 mm



AGD01301
Drainer
Easy L

59

new

Dim.: 254 x 145 x 90 mm



AVI03304
Colander
Easy S

60

new

Dim.: 462 x 134 x 72 mm



AVI03305
Colander
std L

61

new

Dim.: 255 x 176 x 93 mm

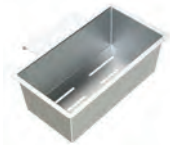

AVI03306
Colander 475
std S

62

new

Dim.: 400 x 284 x 80 mm



AVI03307
Colander
Easy Corner

63

new

Dim.: 340 x 250 mm

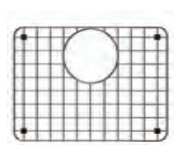

AGB01301
Bottom grid
std S

64

new

Dim.: 315 x 310 mm

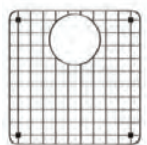

AGB01302
Bottom grid
std M

65

new

Dim.: 285 x 360 mm

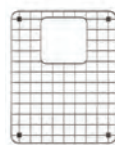

AGB01305
Bottom grid S

66

new

Dim.: 455 x 330 mm

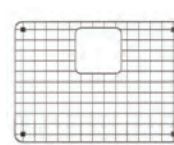

AGB01304
Bottom grid M

67

new

Dim.: 590 x 330 mm

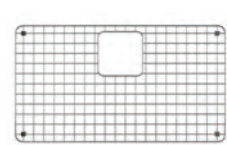

AGB01303
Bottom grid L

68

To mixers
and accessories
holes.



AKF30000
Diamond core kit
Ø 35 mm



RFP01300
Madeira and Indo
mixers filter

WASTE DRAINS



ASP23000
Pop-up waste 2 ways - 3,5"
round strainer plug and square
control knob

140



ASP13000
Pop-up waste 1 way - 3,5"
round strainer plug and square
control knob

141



ANP13000
Waste accessory
kit 1 way - 3,5"
manual square strainer plug

142



ASP13001
Pop-up waste 1 way - 3,5"
square strainer plug and
control knob

143



ASP16300
Pop-up waste 1 way - 3,5"
square strainer plug and
control knob for Karisma collection

144



ASP17000
Pop-up waste 1 way - 3,5"
round strainer plug and cube
control knob Value

145



ACPM1000
Manual waste
cover

146



ACPA1000
Pop-up waste
cover

147



APM2VCTPGO
Euro 105
Piletta 3,5"
2 vie ottonata

148



APM1VCTPGO
Euro 59
Piletta 3,5"
1 via ottonata

149

elleci waste drains



ECHO waste bins

Great capacity separate collection

Conceived for everyone who wishes a waste bin fit for voluminous separate collection. Three containers with a 65 litres total capacity allow to completely exploit the inner cabinet room. The swiveling lid assures both a practical use and excellent closing as well; the waste bins run out by total extraction slides. Fixing to the bottom of the cabinet.



- Containers: 2x30 L, 1,5 L.
- Height 51 mm: suitable for cabinet placed under the SIR.
- Full extraction slides.
- Suitable for 450 mm base.
- Fixing to the bottom of the cabinet.
- Colour: light grey.

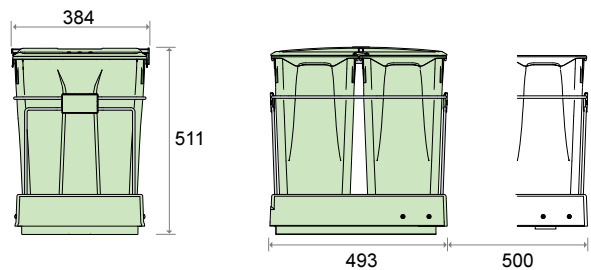

WASTE BINS	CODE
ECHO 4565	APR02300

For the first time it is possible to place 65 litres containers under the sink, thanks to the Elleci patented compact draining system: **ELLECI SIR.**



Elleci waste bins installation under the sink

✓ ok ✗ no

Waste bin model / H kitchen top	TOP 4 cm	TOP 5 cm	TOP 6 cm	TOP +6 cm
ECHO 4565 (65 L)	✗	✗	✓ <i>just under Dogma</i>	✓ <i>just under Dogma, Sirex and Smart</i>
ECHO 4531 (31 L) and 4532 (32 L)	✓	✓	✓	✓
ECHO 4505 (5 L)	✓	✓	✓	✓

Full extraction containers

Very functional and easy to use, these waste bins are expressly designed to make easier the domestic waste collection, even if in the smallest places. They allow the space available to be exploited at best also thanks to the peculiar design of the lid on which gloves and sponges can be placed.



ECHO 4532

32 Litres

- Containers: 2x16 L.
- Suitable for 450 mm base in case of automatic extraction.
- Patented automatic pull-out system.
- Lid designed to rest sponges and gloves on; easy to remove for an easier cleaning.
- Colour: light grey.

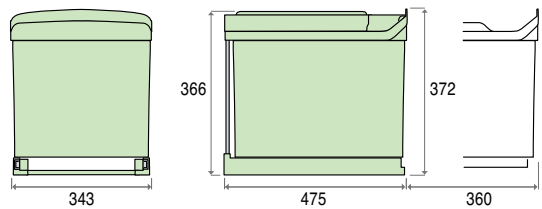

WASTE BINS	CODE
ECHO 4532	APR01300



ECHO 4531

31 Litres

- Containers: 1x16 L, 2x7,5 L.
- Suitable for 450 mm base in case of automatic extraction.
- Patented automatic pull-out system.
- Lid designed to rest sponges and gloves on; easy to remove for an easier cleaning.
- Colour: light grey.

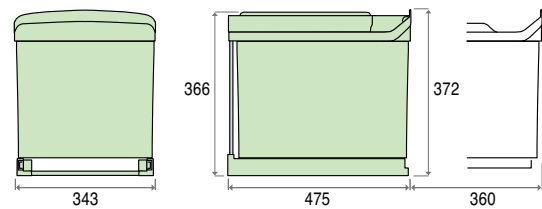

WASTE BINS	CODE
ECHO 4531	APR01301



ECHO 4505

5 Litres

- Design style container: 1x5 L.
- Practical for food waste.
- Equipped with lid and bag holder system.
- It can be hooked onto furniture or handle for easier use.
- Easy to clean and dishwasher safe.
- Colour: light grey, green lid.

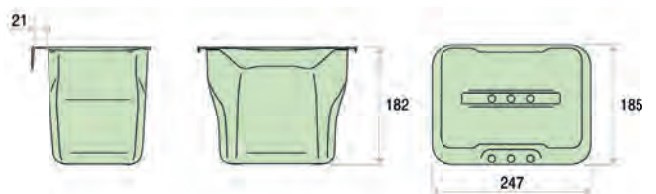

WASTE BINS	CODE
ECHO 4505	APR01302

Complements

Additional sources for everything you need at your fingertips and at the same time decorate your kitchen with stainless steel accessories with elegance.



334
335



ARI11000
Stainless steel shelf

100



ASI01000
Double stainless steel shelf

101



ARI02100
Stainless steel paper-roll holder

102



ARI12000
Double stainless steel shelf

103



ABI11300
120 cm stainless steel bar with hooks

105



AMI01300
Stainless steel cutlery tray

106



ABI02300
90 cm stainless steel bar

107



ABI12300
120 cm stainless steel bar

108

Cleaning products

Specific and effective detergents for the cleaning and treatment of our products.



1. ORDINARY MAINTENANCE

The best way to clean the sink is to use a cloth or a soft sponge diluting detergents commonly used with warm water. It is recommended not to use aggressive detergents.

It is recommended to rinse the sink surface with water, drying the humid parts with a spongy cloth. All these cares will contribute to prevent limestone formation, above all upon dark coloured sinks.

2. STUBBORN STAINS REMOVAL

Stubborn dirt traces can be removed with a cloth soaked into bleach diluted with water or with alcohol or, in extreme cases, with acetone. After this operation carefully rinse the surface with water.

3. EXTRAORDINARY INTERVENTION

The sink is made up of a mixture with a high percentage of fillers, which make the product very hard and resistant. This can cause formation of streaks as a result of continuous rubbing of metal pans. A streak is a little metallic particle releasing and it can be removed with brushes and commonly used detergents.

4. FURTHER SUGGESTIONS

Do not use highly alkaline substances such as ammonia or caustic soda. Do not place hot pots or coffee machines directly on the sink (in some cases, just taken off from fire they can reach up to 500°C). Do not pour boiling oil, pipes could be clogged and be damaged by deformations. Do not cut directly on the sink surface, we recommend to use the proper cutting board. Limestone residuals are removed with vinegar or acetic acid.

31

Composite sinks

Elleci Beauty SPA for Granitek, Metaltek e Vitrotek. A 500 ml bottle.

For an accurate cleaning of sinks in Vitrotek, Metaltek and Granitek. Effective stains removal. Instructions for persistent stains: to pour the detergent on the stained part and leave it acting for 1-2 minutes and remove, making a light pressure. Shake well before using.

DLL01600
Total Clean



32

Antiscale

Elleci Beauty SPA descale, for composite sinks. A 500 ml bottle.

Particularly suitable for hard waters in order to remove scale residuals. Shake well before using.

DLA01600
Antiscale



33

Stainless steel sinks

Elleci Beauty SPA for stainless steel. A 500 ml bottle.

For an accurate cleaning of our sinks components and accessories in stainless steel. Effective stains removal. Instructions for persistent stains: to pour the detergent on the stained part and leave it acting for 1-2 minutes and remove, making a light pressure. Shake well before using.

DLI01600
Active inox



Comparative schedule

Main household appliances manufactures

VITROTEK 3G	HOTPOINT	INDESIT	ELECTROLUX	WHIRLPOOL	SMEG	BOSCH	SIEMENS	CANDY	BEKO	NARDI
86 black	vetro nero	nero	cristallo nero	vetro nero	vetro nero	vetro nero	vetro nero	nero	nero	nero
92 old white	bianco antico		bianco antico	bianco antico	panna					
94 ice	ghiaccio									
95 champagne	champagne					champagne				
96 white	vetro bianco	bianco	cristallo bianco	vetro bianco	vetro bianco		vetro bianco	bianco		bianco
97 silver	argento									
METALTEK										
72 rame	rame		rame		rame					ramato
73 titanium					titano					
75 bronze					ottone					
79 aluminium	argento				alluminio			aqua		black pearl
GRANITEK										
40 full black	nero	nero	nero	nero	nero	nero		nero	nero	
43 tortora		tortora								
51 avena	avena	avena	sabbia	avena	avena			avena	avena	granito beige
52 bianco	granito bianco		pietra		bianco					
53 terra										
54 nero										granito nero
57 pietra vecchia	pietra vecchia									
59 antracite	antracite	antracite	nero ghisa	antracite	antracite			ghisa	antracite	antracite
61 pietra antica	pietra antica									
62 bianco antico	bianco antico		bianco antico	bianco antico	panna					avorio
68 bianco titano	bianco	bianco	bianco	bianco	bianco	bianco		bianco	bianco	bianco
SINTEK										
11 bianco	bianco	bianco	bianco	bianco	bianco	bianco		bianco	bianco	bianco
12 terra di francia			terra di francia		terra di francia					terra di francia
13 nero	nero	nero	nero	nero	nero	nero		nero		
14 bianco antico	bianco antico		bianco antico	bianco antico	panna					avorio



The producer is not responsible for any kind of printing errors.
 Elleci reserves the faculty to make any ameliorative or indispensables changes without alters essential features of products.
 All products could be changed in respect of CE ameliorative requests.